

320C 320C L

Hydraulic Excavator



JC Machinery
excavatorhunter.com

Engine

Engine Model	Cat® 3066 T Diesel Engine	
Flywheel Power	103 kW	138 hp

Weights

Operating Weight - Long Undercarriage	21 000 kg	46,300 lb
--	-----------	-----------

Drive

Maximum Drawbar Pull	196 kN	44,040 lb
Maximum Travel Speed	5.5 kph	3.4 mph

SUNIGHT

320C/320C L Hydraulic Excavator

The C Series incorporates innovations for improved performance and versatility.

Engine and Hydraulics

The Cat 3066 T engine and proven hydraulics combine to give the 320C consistently high power and control in the field. **pg. 4**

Structures

Rugged Caterpillar® undercarriage design and proven structural manufacturing techniques assure outstanding durability in the toughest applications. **pg. 5**

Booms and Sticks

Designed-in flexibility helps bring higher production and efficiency to all jobs. **pg. 6**

Complete Customer Support

Your Cat dealer offers a wide range of services that can be set up under a Customer Support Agreement when you purchase your equipment. The dealer will help you choose a plan that can cover everything from machine and attachment selection to replacement. **pg. 10**

Increased work tool options, improved cycle times, and ease of operation lead to increased productivity and lower operating costs.



Work Tools - Attachments

A variety of bucket types and sizes with aggressive designs ensure excellent performance in a variety of applications. **pg. 7**

Operator Station

- ✓ Redesigned interior layout maximizes operator space, provides exceptional comfort and reduces operator fatigue. **pg. 8**

Serviceability

Longer service intervals and easier maintenance results in better machine availability and lower owning and operating costs. **pg. 9**



JC Machinery

SUNIGHT

✓ *New Feature*

excavatorhunter.com

Engine and Hydraulics

Cat 3066 T engine and hydraulics give the 320C exceptional power, efficiency and controllability unmatched in the industry for consistently high performance in all applications.



Low sound, low vibration. 3066 T design improves operator comfort by reducing sound and vibration.

Hydraulic Cross Sensing System. Improves productivity with faster implement speeds and quicker, stronger pivot turns.

Optional Fine Swing Control. Optional Fine Swing Control cushions swing start and stop for better implement control.

Hydraulic Cylinder Snubbers. The hydraulic cylinder snubbers at rod-end of boom cylinders and both ends of stick cylinders cushion shocks, reduce sound and increase cylinder life, keeping the machine working longer.

Controllability. The hydraulic system offers precise control to the 320C, reducing operator fatigue, improving operator effectiveness and efficiency, which ultimately translates into enhanced performance.

Boom and Stick Regeneration Circuit. Boom and stick regeneration circuit increases efficiency and reduces cycle times for higher productivity and lower operating costs.

Engine. Six cylinder turbocharged engine built for power, reliability, economy and low emissions will keep the machine up and running.

Automatic Engine Speed Control. Automatic Engine Control with convenient one-touch command. Three-stage control maximizes fuel efficiency and reduces sound levels.



Structures

320C structural components and undercarriage are the backbone of the machine's durability.

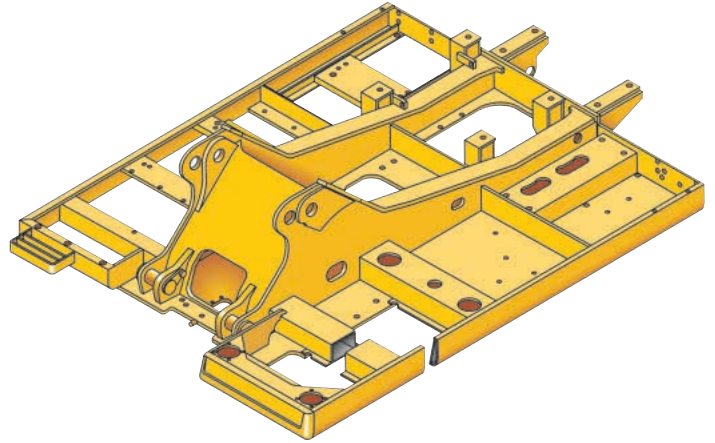
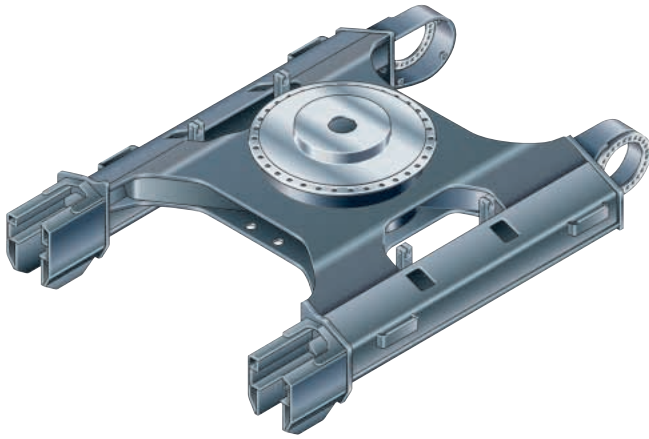

Robotic Welding. Over 95% of the structural welds on a Caterpillar excavator are completed by robots. Robotic welds achieve over three times the penetration of manual welds.

Carbody Design and Track Roller Frames. X-shaped, box-section carbody provides excellent resistance to torsional bending. Robot-welded track roller frames are press-formed, pentagonal units to deliver exceptional strength and service life.

Main Frame. Rugged main frame is designed for maximum durability and efficient use of materials.

Undercarriage. Durable Cat undercarriage absorbs stresses and provides excellent stability.

Rollers and Idlers. Sealed and lubricated track rollers, carrier rollers and idlers provide excellent service life, to keep the machine in the field longer.

Undercarriage Options. Two undercarriage options, standard (STD) and long (L), allow you to choose the best configuration for your application.

Standard Undercarriage. The standard undercarriage is well suited for applications that require frequent repositioning of the machine, have restricted working space, uneven or rocky terrain.

Long Undercarriage. The long (L) undercarriage maximizes stability and lift capacity. A long, wide and sturdy undercarriage offers a very stable work platform.



Booms and Sticks

Designed-in flexibility helps bring higher production and efficiency to all jobs.

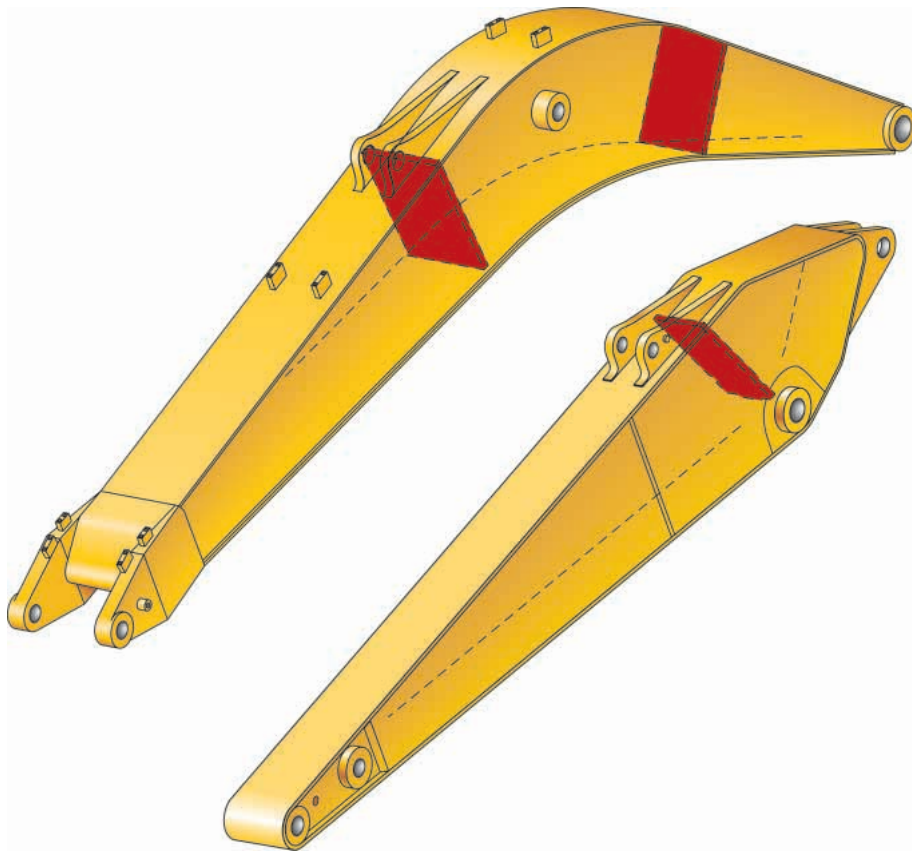

Booms and Sticks. Built for performance and long service life, Caterpillar booms and sticks are large, welded, box-section structures with thick, multi-plate fabrications in high-stress areas.

Reach Boom. The reach boom features an optimum design that maximizes digging envelopes with three stick choices.

R3.9B Stick. The R3.9B stick gives the largest working envelope with smaller buckets.

R2.9B Stick. The R2.9B stick is a versatile front linkage.

R2.5B Stick. The R2.5B stick provides a good digging envelope with larger buckets and stability for hammer work.

Mass Excavation Boom. The mass excavation boom maximizes productivity. The M version offers significantly higher digging forces and allows use of larger buckets.

M2.4C Stick. The M2.4C stick gives a limited envelope but allows the use of large buckets with high digging forces.

Special Application (SA) Reach Boom. The Special Application (SA) reach booms and sticks are designed for severe applications. R2.9B SA and R2.5B SA sticks are offered as options.

Protection Bumpers. Caterpillar side impact protection (optional) bumpers help protect machines from damage, reducing repair and service time. Rubber is bonded to high-strength steel plates and bolted to the upper frame.



Work Tools - Attachments

Increased offerings of work tools help optimize machine performance.

Buckets. Caterpillar buckets provide increased service life with reduced repair costs.

Heavy-Duty Rock (HDR) Buckets.

Heavy-Duty Rock (HDR) buckets perform best when digging fragmented rock, frozen ground, caliche and highly abrasive materials. Additional, thicker wear plates extend beyond side plates for corner and rear dent protection. Sidebar protectors decrease sidebar wear.

Heavy-Duty Rock Ripping (RR) Buckets.

These buckets (C family only) dig hard rock and work in areas where material is virgin or poorly prepared. Stepped tooth design allows one or two tip penetration for higher break-out forces and keeps the trench floor flat. Thicker side wear plates, cutting edges and larger Ground Engaging Tools (GET) mean additional wear life.

General Purpose (GP) Buckets. General Purpose (GP) buckets are best for digging in soft to hard ground with low to moderate abrasive materials.

Ditch Cleaning (DC) Buckets. These are wide shallow buckets for bank forming, ditch cleaning and finishing.



Heavy-Duty (HD) Buckets. Heavy-Duty (HD) buckets for digging in moderate to hard abrasive materials feature large Ground Engaging Tools (GET), thick cutting edges and thick bottom and side wear plates to improve performance in demanding conditions.

Tool Control System. The optional Tool Control System maximizes work tool productivity by configuring hydraulic flow, pressure, and operator controls to match a specific work tool. System versatility enables a wide range of tools to be used. Up to five different tool settings may be pre-programmed and selected from the cab. Factory installed hammer and thumb circuits are also available as attachments.



Heavy Duty Power (HDP) Buckets.

Designed to improve breakout force and machine cycle times, the Heavy Duty Power (HDP) Bucket compliments the General Purpose, Heavy Duty, and Heavy Duty Rock bucket lines.

Quick Couplers. The Pin Grabber Plus and the Dedicated Hydraulic Quick Couplers are available as field installed options. These attachments greatly enhance machine versatility by enabling the rapid changeover of a wide range of work tools in the field.

Work Tools. Choose from a variety of work tools such as hammers, shears, rotators, grapples or crushers. Ask your Cat dealer for information on attachments or special configurations.



Operator Station

Redesigned interior layout maximizes operator space, provides exceptional comfort and reduces operator fatigue.



Operator Station. The 320C operator work station is quiet with ergonomic control placement and convenient adjustments, low lever and pedal effort, ergonomic seat design and highly efficient ventilation.

Redesigned Layout. Redesigned cab layout emphasizes simplicity and ease of use. Right-hand wall and console provide easy access to all switches, dials and controls.

Travel Controls. A large rubber-covered footrest at the side of the travel pedals allows the foot to easily grip the pedal. The travel lever stroke and force have been enhanced to improve the 320C's fine controllability, making the machine easier to operate.

Seat. New, two-tone seat offers soft and firm cushions for operator comfort. Reclining knob is located at the right side of the seat for easy adjustment.

Console. Redesigned consoles for simplicity and functionality. Both consoles have attached adjustable armrests.

Automatic Climate Control. Fully automatic climate control adjusts temperature and flow and determines which air outlet is best in each situation.

Upper Cab Door Window. The upper cab door window slides open, providing extra ventilation and allowing communication with people outside.

Skylight. A large polycarbonate skylight delivers excellent natural lighting and good ventilation. Standard sliding sunshade protects from direct sunlight.

Automatic Boom and Swing Priority Function. For simpler operation, work mode and power mode switches have been eliminated. Instead, the automatic boom and swing priority function selects the best mode, based on joystick movement.

Monitor. New, compact monitor enhances viewing while displaying a variety of easy to read and understand language-based information.



Serviceability

Simplified service and maintenance features save you time and money.

Extended Service Interval. 320C service and maintenance intervals have been extended to reduce machine service time and increase machine availability.

Radiator Compartment. The left rear service door allows access to the engine radiator and hydraulic oil cooler, which are side by side, and the high performance compact air-to-air aftercooler (ATAAC). Ample space between the ATAAC and the radiator/cooler is provided to allow access for cleaning.

Air Filter Compartment. The air filter features a double-element construction for superior cleaning efficiency. When the air cleaner plugs, a warning is displayed on the monitor screen inside the cab.

Ground Level Service. The design and layout of the 320C was made with the service technician in mind. Many service locations are easily accessible at ground level allowing critical maintenance to get done quickly and efficiently.

Swing-Out Condenser. The air conditioner condenser swings out horizontally for cleaning access.

Pump Compartment. A service door on the right side of the upper structure allows ground-level access to the pump and pilot filter.

Capsule Filter. The hydraulic return filter, a capsule filter, is situated outside the hydraulic tank. This filter prevents contaminants from entering the system when hydraulic oil is changed and keeps the operation clean.



Diagnostics and Monitoring. The 320C is equipped with S•O•SSM sampling ports and hydraulic test ports for the hydraulic system, engine oil and for coolant. A test connection for the Cat Electronic Technician (Cat ET) is located behind the cab.

Handrails and Steps. Larger handrails and steps assist operator in climbing on and off machine.

Anti-Skid "Punched Star" Plate. Anti-skid punched-star plate covers top of storage box and upper structure to prevent slipping during maintenance. The plate can be removed for cleaning.

Grease Lubricated Track. Grease lubricated seals protect the track link and deliver long track link pin and bushing inner wear life.



JC Machinery

SUNIGHT

excavatorhunter.com

Complete Customer Support

Cat dealer services help you operate longer with lower costs.



Selection. Make detailed comparisons of the machines you are considering before you buy. What are the job requirements? What production is needed? What is the true cost of lost production? Your Cat dealer can give you precise answers to these questions.

Acquisition. Look past initial price, look at the value the 320C offers. Consider the financing options available as well as day-to-day operating costs.

Operation. Improving operating techniques can boost your profits. Your Cat dealer has training literature and other ideas to help you increase productivity.

Maintenance. Repair option programs guarantee the cost of repairs up front. Diagnostic programs such as Scheduled Oil Sampling and Technical Analysis help you avoid unscheduled repairs.

Replacement. Repair, rebuild or replace? Your Cat dealer can help you evaluate the cost involved so you can make the right choice.

Product Support. You will find nearly all parts at our dealer parts counter. Cat dealers utilize a worldwide computer network to find in-stock parts to minimize machine down time. Save money with remanufactured components.



Engine

Engine Model	Cat 3066 T Diesel Engine	
Flywheel Power	103 kW	138 hp
ISO 9249	103 kW	138 hp
SAE J1349	103 kW	138 hp
EEC 80/1269	103 kW	138 hp
Bore	102 mm	4.02 in
Stroke	130 mm	5.12 in
Displacement	6.37 L	389 in ³
Gross Power	107 kW	143 hp

- The 320C/320C L meets US Tier 2 and EU Stage II emissions requirements.
- Net power advertised is the power available at the flywheel when the engine is equipped with fan, air cleaner, muffler, and alternator.
- No engine derating required below 2300 m (7,500 ft) altitude.

Weights

Operating Weight - Long Undercarriage	21 000 kg	46,300 lb
Operating Weight - Std. Undercarriage	19 700 kg	43,400 lb

Service Refill Capacities

Fuel Tank Capacity	400 L	106 gal
Cooling System	30 L	7.9 gal
Engine Oil	30 L	7.9 gal
Swing Drive	8 L	2.1 gal
Final Drive (each)	10 L	2.6 gal
Hydraulic System (including tank)	200 L	53 gal
Hydraulic Tank	120 L	32 gal

Sound Performance

- The operator sound exposure Leq (equivalent sound pressure level) measured according to the work cycle procedures specified in ANSI/SAE J1166 OCT98 is 74 dB(A), for the cab offered by Caterpillar, when properly installed and maintained and tested with the doors and windows closed.

Standards

Brakes	SAE J1026 APR90	
Cab/FOGS	SAE J1356 FEB88 ISO 10262	

Hydraulic System

Main Implement System - Maximum Flow (2x)	205 L/min	54.2 gal/min
Max. pressure - Implements (Full Time)	34 300 kPa	4,980 psi
Max. pressure - Travel	34 300 kPa	4,980 psi
Max. pressure - Swing	25 000 kPa	3,625 psi
Pilot System - Maximum flow	41 L/min	10.8 gal/min
Pilot System - Maximum pressure	4120 kPa	600 psi
Boom Cylinder - Bore	120 mm	5 in
Boom Cylinder - Stroke	1260 mm	52 in
Stick Cylinder - Bore	140 mm	5.5 in
Stick Cylinder - Stroke	1430 mm	56 in
B Family Bucket Cylinder - Bore	120 mm	5 in
B Family Bucket Cylinder - Stroke	1030 mm	41 in
C Family Bucket Cylinder - Bore	130 mm	5 in
C Family Bucket Cylinder - Stroke	1150 mm	46 in

Drive

Maximum Drawbar Pull	196 kN	44,040 lb
Maximum Travel Speed	5.5 kph	3.4 mph

Swing Mechanism

Swing Speed	11.5 RPM	
Swing Torque	61.8 kN·m	45,611 lb ft

Track

Standard w/Standard Undercarriage	600 mm	24 in
Standard w/Long Undercarriage - Triple Grouser	800 mm	32 in
Optional	600 mm	24 in
Optional	700 mm	28 in
Optional	800 mm	32 in

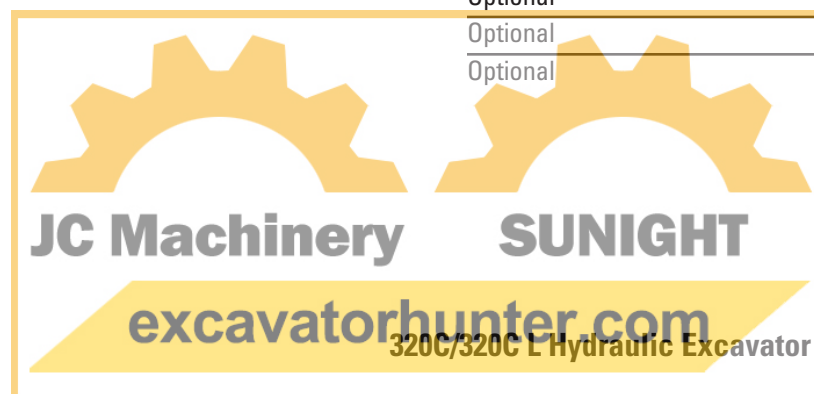

Dimensions and Weights

All dimensions are approximate.

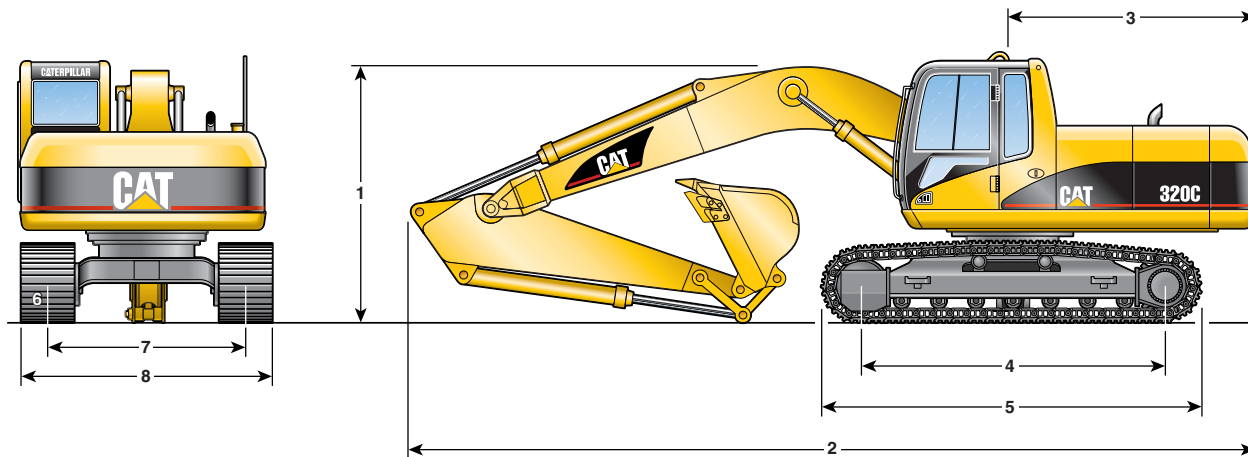

	R3.9B (12'8") Stick	R2.9B (9'7") Stick Std/SA	R2.5B (8'2") Stick Std/SA
Reach Boom 5.68 m (18'7")			
1 Shipping height	3430 mm (11'3")	3010 mm (9'11")	3010 mm (9'11")
2 Shipping length	9420 mm (30'11")	9440 mm (31'0")	9460 mm (31'0")
3 Tail swing radius	2750 mm (9'0")	2750 mm (9'0")	2750 mm (9'0")
4 Length to center of rollers			
Standard	3265 mm (10'9")	3265 mm (10'9")	3265 mm (10'9")
Long	3650 mm (12'0")	3650 mm (12'0")	3650 mm (12'0")
5 Track length			
Standard	4075 mm (13'4")	4075 mm (13'4")	4075 mm (13'4")
Long	4455 mm (14'7")	4455 mm (14'7")	4455 mm (14'7")
6 Ground clearance	475 mm (1'7")	475 mm (1'7")	475 mm (1'7")
7 Track gauge			
Standard	2200 mm (7'3")	2200 mm (7'3")	2200 mm (7'3")
Long	2380 mm (7'10")	2380 mm (7'10")	2380 mm (7'10")
8 Transport width			
Standard	800 mm (32") shoes 3000 mm (9'10")	700 mm (28") shoes 2900 mm (9'6")	600 mm (24") shoes 2800 mm (9'2")
Long	3180 mm (10'5")	3080 mm (10'1")	2980 mm (9'9")

	M2.4C (7'10") Stick
Mass Boom 5.2 m (17'1")	
1 Shipping height	3050 mm (10'0")
2 Shipping length	9000 mm (29'6")
Long Reach Front (320C L)	800 mm (32") only
1 Shipping height	3210 mm (10'6")
2 Shipping length	12 660 mm (41'6")

Operating Weight	600 mm (24") Shoes (320C)		800 mm (32") Shoes (320C L)	
	kg	lb	kg	lb
Reach Boom				
Stick Options:				
3.9 m (12'8")	20 000	44,000	21 200	46,700
2.9 m (9'7")	19 700	43,400	21 000	46,300
2.5 m (8'2")	19 700	43,400	21 000	46,300
Mass Boom				
Stick Option:				
2.4 m (7'10")	20 200	44,500	21 500	47,400
Long Reach				
Total Weight	22 680	49,900		

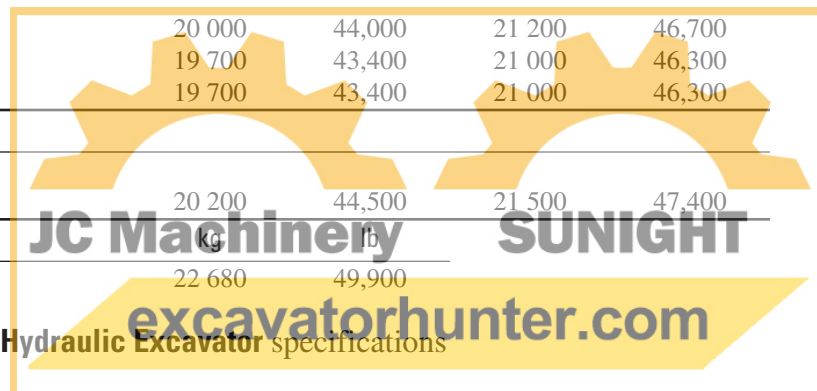

Reach Excavator Working Ranges

Reach (R) Boom configuration

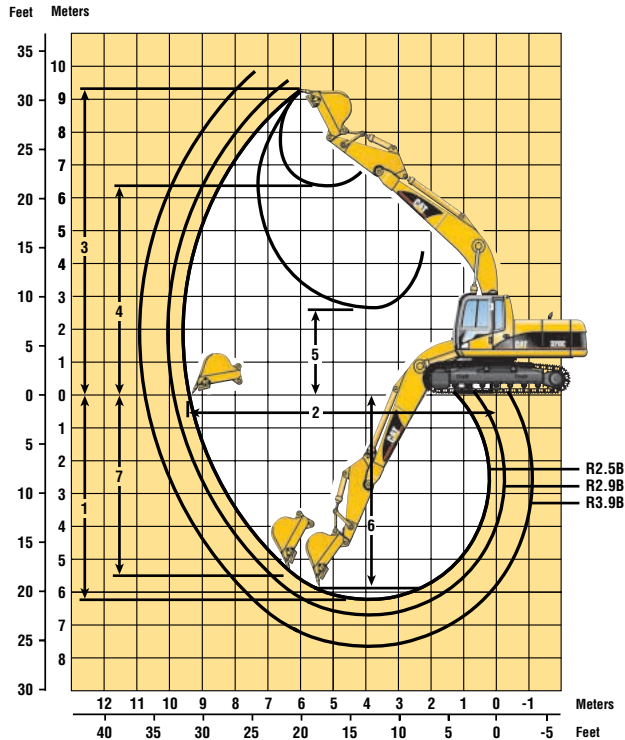

Major Component Weights

Booms: including lines, boom cylinders, stick cylinders and left side light

	kg	lb
Reach	2030	4476
Reach (SA)	2194	4838

Sticks: including bucket cylinder and bucket linkage

	kg	lb
R3.9B	1250	2756
R2.9B	999	2203
R2.9B SA	1101	2427
R2.5B	974	2148
R2.5B SA	1038	2289

Counterweight	3850	8500
---------------	------	------

Stick Length	R3.9B (12'8")	R2.9B (9'7")	R2.5B (8'2")
Bucket	1 m³ (1.3 yd³)	1 m³ (1.3 yd³)	1 m³ (1.3 yd³)
1 Maximum Digging Depth	7.66 m (25'1")	6.72 m (22'0")	6.33 m (20'9")
2 Maximum Reach at Ground Level	10.71 m (35'2")	9.86 m (32'4")	9.46 m (31'0")
3 Maximum Cutting Height	9.82 m (32'2")	9.49 m (31'1")	9.30 m (30'6")
4 Maximum Loading Height	6.85 m (22'5")	6.50 m (21'4")	6.30 m (20'8")
5 Minimum Loading Height	1.23 m (4'0")	2.17 m (7'11")	2.59 m (8'5")
6 Maximum Depth Cut for 2440 mm (8') Level Bottom	7.31 m (24'0")	6.37 m (20'10")	5.95 m (19'6")
7 Maximum Vertical Wall Digging Depth	6.86 m (22'6")	6.05 m (19'10")	5.65 m (18'6")

Bucket and Stick Forces

Power Buckets

Stick	R3.9B (12'8")		R2.9B (9'7")		R2.5B (8'2")	
Bucket Digging Force (ISO)	159 kN	35,800 lb	159 kN	35,800 lb	159 kN	35,800 lb
Stick Digging Force (ISO)	86 kN	19,300 lb	103 kN	23,100 lb	117 kN	26,300 lb
Bucket Digging Force (SAE)	142 kN	31,800 lb	142 kN	31,800 lb	142 kN	31,800 lb
Stick Digging Force (SAE)	84 kN	18,900 lb	100 kN	22,400 lb	113 kN	25,400 lb

HD and HDR Buckets

Stick	R3.9B (12'8")		R2.9B (9'7")		R2.5B (8'2")	
Bucket Digging Force (ISO)	145 kN	32,500 lb	145 kN	32,500 lb	145 kN	32,500 lb
Stick Digging Force (ISO)	84 kN	18,900 lb	100 kN	22,500 lb	113 kN	25,500 lb
Bucket Digging Force (SAE)	128 kN	28,900 lb	128 kN	28,900 lb	128 kN	28,900 lb
Stick Digging Force (SAE)	82 kN	18,500 lb	97 kN	21,800 lb	110 kN	24,600 lb

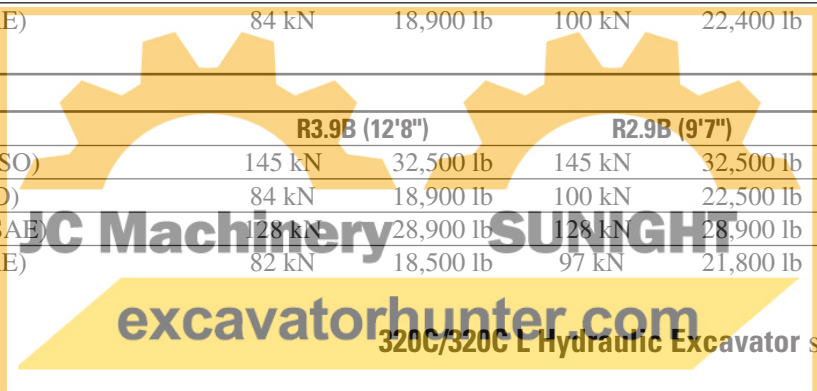

Mass Excavator Working Ranges

Mass (M) Boom configuration

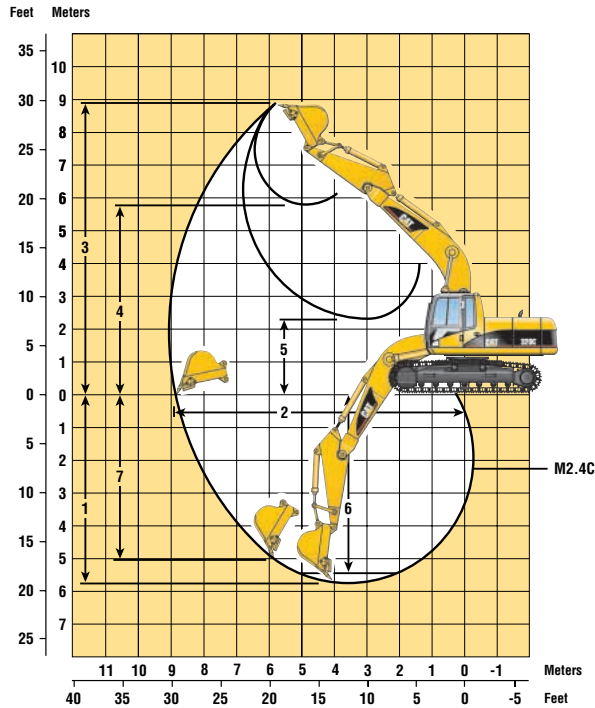

Stick Length	M2.4C (7'10")
Bucket	1.3 m³ (1.7 yd³)
1 Maximum Digging Depth	5.84 m (19'2")
2 Maximum Reach at Ground Level	8.91 m (29'2")
3 Maximum Cutting Height	8.90 m (29'2")
4 Maximum Loading Height	5.77 m (18'11")
5 Minimum Loading Height	2.28 m (7'5")
6 Maximum Depth Cut for 2440 mm (8') Level Bottom	5.50 m (18'0")
7 Maximum Vertical Wall Digging Depth	5.05 m (16'6")

Bucket and Stick Forces

HD and HDR Buckets		
Stick	M2.4C (7'10")	
Bucket Digging Force (ISO)	163 kN	36,700 lb
Stick Digging Force (ISO)	126 kN	28,200 lb
Bucket Digging Force (SAE)	144 kN	32,500 lb
Stick Digging Force (SAE)	121 kN	27,200 lb

Power Buckets		
Stick	M2.4C (7'10")	
Bucket Digging Force (ISO)	182 kN	41,000 lb
Stick Digging Force (ISO)	129 kN	28,900 lb
Bucket Digging Force (SAE)	161 kN	36,100 lb
Stick Digging Force (SAE)	124 kN	27,800 lb

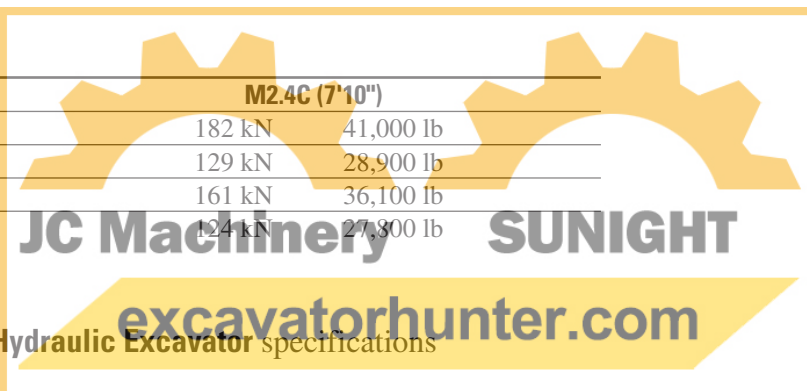

Major Component Weights

Booms: including lines, boom cylinders, stick cylinders and left side light

	kg	lb
Mass	2048	4516

Sticks: including bucket cylinder and bucket linkage

	kg	lb
M2.4C	1200	2646

Counterweight	3850	8500
---------------	------	------

Long Reach Excavator Working Ranges

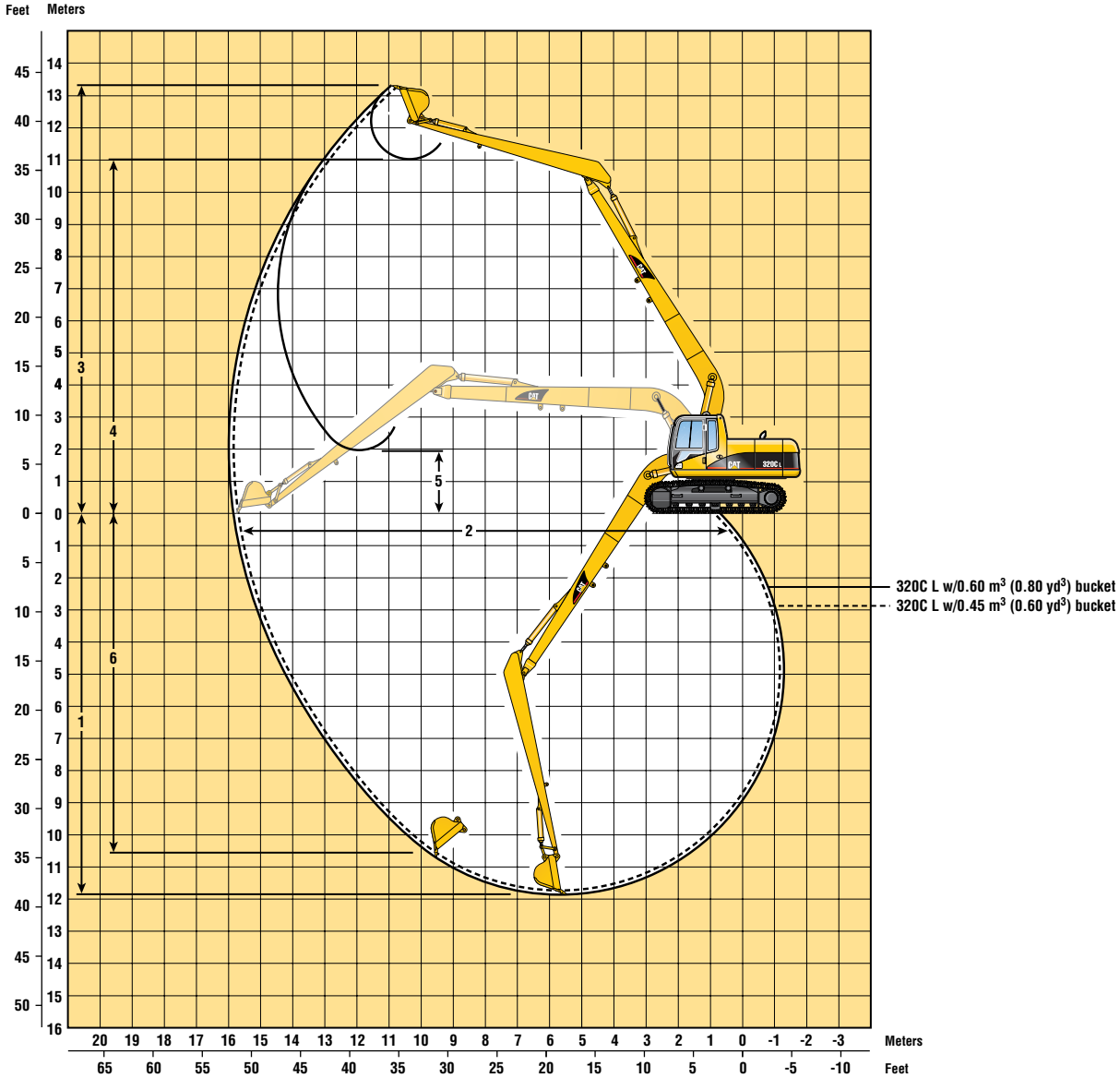

Arrangements	320C L SLR 0.45 m ³ (0.60 yd ³) Excavation	320C L SLR 0.60 m ³ (0.80 yd ³) Ditch
1 Maximum Digging Depth	11.88 m (39'0")	11.75 m (38'7")
2 Maximum Reach at Ground Level	15.72 m (51'7")	15.59 m (51'2")
3 Maximum Cutting Height	13.29 m (43'7")	13.23 m (43'5")
4 Maximum Loading Height	11.01 m (36'1")	11.14 m (36'6")
5 Minimum Loading Height	1.97 m (6'6")	2.09 m (6'10")
6 Maximum Vertical Wall Digging Depth	10.7 m (35'1")	11.31 m (37'1")
Bucket Digging Force (ISO)	60 kN (13,500 lb)	60 kN (13,500 lb)
Stick Digging Force (ISO)	46 kN (10,300 lb)	46 kN (10,300 lb)
Bucket Digging Force (SAE)	54 kN (12,100 lb)	60 kN (13,500 lb)
Stick Digging Force (SAE)	46 kN (10,300 lb)	46 kN (10,300 lb)

Major Component Weights

Booms: including lines, boom cylinders, stick cylinders and left side light

	kg	lb
Boom	2180	4800

Sticks: including bucket cylinder and bucket linkage

Stick	1600	3520
-------	------	------

Counterweight	4830	10,630
---------------	------	--------

Bucket Specifications

320C (Standard Undercarriage) and 320C L (Long Undercarriage)

Contact your Caterpillar dealer for special bucket requirements.

B Buckets for Reach Linkage	Capacity*		Width		Tip Radius		Weight (without tips)		Teeth Qty	320C – Reach Boom Stick			320C L – Reach Boom Stick		
	m ³	yd ³	mm	in	mm	in	kg	lb		R3.9B (12'8")	R2.9B (9'7")	R2.5B (8'2")	R3.9B (12'8")	R2.9B (9'7")	R2.5B (8'2")
General Purpose (GP)	0.70	0.88	775	30	1626	64.0	665	1463	4	●	●	●	●	●	●
	0.90	1.12	932	36	1626	64.0	741	1630	5	○	●	●	●	●	●
	1.10	1.50	1082	42	1626	64.0	777	1710	5	∴	○	●	○	●	●
	1.30	1.75	1230	48	1626	64.0	907	1995	6	–	∴	○	∴	○	●
Heavy Duty (HD)	0.45	0.62	625	24	1563	61.5	639	1405	3	●	●	●	●	●	●
	0.60	0.75	775	30	1563	61.5	691	1520	4	●	●	●	●	●	●
	0.80	1.00	932	36	1563	61.5	765	1683	5	●	●	●	●	●	●
	1.00	1.25	1082	42	1563	61.5	814	1790	5	∴	●	●	●	●	●
	1.10	1.50	1230	48	1563	61.5	942	2072	6	–	○	○	∴	●	●
	1.10	1.50	1230	48	1563	61.5	912	2007	6	–	○	○	∴	●	●
	1.30	1.75	1377	54	1563	61.5	1003	2206	7	–	∴	∴	∴	○	●
	1.30	1.75	1377	54	1563	61.5	968	2130	7	–	∴	○	∴	○	●
	Power Bucket (PB)	0.83	1.09	932	36	1406	55	797	1757	5	○	●	●	●	●
1.0		1.31	1082	42	1406	55	863	1903	5	∴	●	●	○	●	●
1.17		1.53	1230	48	1406	55	936	2064	6	–	○	○	∴	●	●
Heavy Duty Rock (HDR)	0.45	0.62	625	24	1563	61.5	727	1600	3	●	●	●	●	●	●
	0.60	0.75	775	30	1563	61.5	845	1860	4	●	●	●	●	●	●
	0.80	1.00	932	36	1563	61.5	864	1900	5	○	●	●	●	●	●
	1.00	1.25	1082	42	1563	61.5	912	2006	5	∴	●	●	●	●	●
Ditch Cleaning (DC)	0.90	1.12	1422	56	1143	45.0	707	1555	0	●	●	●	●	●	●
	1.10	1.50	1727	68	1143	45.0	786	1730	0	∴	○	○	○	●	●

C Buckets for Mass EX Linkage	Capacity*		Width		Tip Radius		Weight (without tips)		Teeth Qty	320C – Mass Boom Stick	320C L – Mass Boom Stick
	m ³	yd ³	mm	in	mm	in	kg	lb		M2.4C (7'10")	M2.4C (7'10")
General Purpose (GP)	0.90	1.12	775	30	1778	70.0	805	1771	3	●	●
	1.10	1.50	948	36	1778	70.0	891	1960	5	●	●
	1.30	1.75	1098	42	1778	70.0	950	2090	5	○	●
	1.60	2.12	1248	48	1778	70.0	1045	2300	6	∴	○
	1.90	2.50	1395	54	1778	70.0	1118	2460	7	–	∴
Heavy Duty (HD)	0.70	0.88	775	30	1638	64.5	836	1839	3	●	●
	0.90	1.12	948	36	1638	64.5	931	2048	4	●	●
	1.10	1.50	1098	42	1638	64.5	1006	2214	5	●	●
	1.30	1.75	1248	48	1638	64.5	1082	2380	5	○	●
	1.50	2.00	1395	54	1638	64.5	1164	2560	6	∴	○
	1.70	2.25	1522	60	1638	64.5	1241	2730	7	–	∴
	1.90	2.50	1680	66	1638	64.5	1326	2918	7	–	∴
Power Bucket (PB)	1.8	2.35	1524	60	1587	62.5	1273	2800	7	–	∴
Heavy Duty Rock (HDR)	0.70	0.88	775	30	1638	64.5	888	1953	3	●	●
	0.90	1.12	948	36	1638	64.5	1043	2295	4	●	●
	1.10	1.50	1098	42	1638	64.5	1127	2480	5	●	●
	1.30	1.75	1248	48	1638	64.5	1211	2664	5	○	●

Assumptions for maximum material density rating:

1. Front linkage fully extended at ground line
2. Bucket curled
3. 100% bucket fill factor

* - Based on SAE J296, some calculations of capacity specs fall on borderlines. Rounding may allow two buckets to have the same English rating, but different metric ratings.

- 2100 kg/m³ (3,500 lbs/yd³) max material density
- 1800 kg/m³ (3,000 lbs/yd³) max material density
- 1500 kg/m³ (2,500 lbs/yd³) max material density
- ∴ 1200 kg/m³ (2,000 lbs/yd³) max material density

Reach Boom Lift Capacities



Load Point Height



Load at Maximum Reach



Load Radius Over Front



Load Radius Over Side

R3.9B STICK – 3900 mm (12'8")
BUCKET – 1.0 m³ (1.3 yd³)

UNDERCARRIAGE – Standard
SHOES – 600 mm (24") triple grouser

BOOM – 5680 mm (18'7")

Load Point Height	1.5 m (5.0 ft)		3.0 m (10.0 ft)		4.5 m (15.0 ft)		6.0 m (20.0 ft)		7.5 m (25.0 ft)		9.0 m (30.0 ft)		Load Radius Over Side		m ft	
	Over Front	Over Side	Over Front	Over Side	Over Front	Over Side	Over Front	Over Side	Over Front	Over Side	Over Front	Over Side	Over Front	Over Side		
7.5 m 25.0 ft	kg lb								*2550 *5550	*2550 *5550			*1400 *3050	*1400 *3050	8.83 28.69	
6.0 m 20.0 ft	kg lb								*3100 *6800	2700 5750			*1300 *2850	*1300 *2850	9.71 31.72	
4.5 m 15.0 ft	kg lb								*3450 *7500	2600 5500	*2400 *5300	1700 3750	*1300 *2850	1300 2800	10.24 33.54	
3.0 m 10.0 ft	kg lb							*4450 *9650	3750 8050	*3900 *8400	2450 5200	2750 5850	1600 3400	*1350 *2950	1150 2500	10.48 34.38
1.5 m 5.0 ft	kg lb			*9200 *22,250	*9200 *22,250	*7400 *15,900	5550 11,900	*5450 *11,700	3450 7400	3750 8050	2300 4900	2650 5700	1550 3250	*1500 *3250	1100 2400	10.46 34.33
Ground Line	kg lb			*6500 *14,850	*6500 *14,850	8500 18,150	5050 10,800	5250 11,250	3200 6800	3600 7700	2150 4550	2600 5550	1500 3100	*1650 *3650	1150 2500	10.18 33.40
-1.5 m -5.0 ft	kg lb	*4400 *9800	*4400 *9800	*8200 *18,650	*8200 *18,650	8200 17,500	4800 10,250	5050 10,850	3000 6450	3500 7500	2050 4350			*2000 *4350	1300 2800	9.61 31.50
-3.0 m -10.0 ft	kg lb	*7200 *16,100	*7200 *16,100	*11 450 *26,100	9400 20,050	8100 17,350	4700 10,100	5000 10,700	2950 6300	3500 7450	2050 4300			*2550 *5600	1600 3500	8.69 28.40
-4.5 m -15.0 ft	kg lb	*10 700 *24,100	*10 700 *24,100	*12 800 *27,500	9650 20,650	8200 17,600	4800 10,300	5050 10,850	3000 6450					*3650 *8250	2300 5150	7.27 23.56
-6.0 m -20.0 ft	kg lb			*9400 *19,800	*9400 *19,800	*6350 *13,100	5100 11,000							*4800 *10,550	3850 8950	5.37 17.15

* Indicates that the load is limited by hydraulic capacity rather than tipping capacity. Lift capacity ratings are based on SAE standard J1097. Rated loads do not exceed 87% of hydraulic lifting capacity or 75% of tipping capacity.

R3.9B STICK – 3900 mm (12'8")
BUCKET – 1.0 m³ (1.3 yd³)

UNDERCARRIAGE – Long
SHOES – 800 mm (32") triple grouser

BOOM – 5680 mm (18'7")

Load Point Height	1.5 m (5.0 ft)		3.0 m (10.0 ft)		4.5 m (15.0 ft)		6.0 m (20.0 ft)		7.5 m (25.0 ft)		9.0 m (30.0 ft)		Load Radius Over Side		m ft	
	Over Front	Over Side	Over Front	Over Side	Over Front	Over Side	Over Front	Over Side	Over Front	Over Side	Over Front	Over Side	Over Front	Over Side		
7.5 m 25.0 ft	kg lb								*2550 *5550	*2550 *5550			*1400 *3050	*1400 *3050	8.83 28.69	
6.0 m 20.0 ft	kg lb								*3100 *6800	*3100 *6700			*1300 *2850	*1300 *2850	9.71 31.72	
4.5 m 15.0 ft	kg lb								*3450 *7500	3000 6450	*2400 *5300	2050 4500	*1300 *2850	*1300 *2850	10.24 33.54	
3.0 m 10.0 ft	kg lb							*4450 *9650	4350 9350	*3900 *8500	2900 6150	*3100 *6050	1950 4150	*1350 *2950	*1350 *2950	10.48 34.38
1.5 m 5.0 ft	kg lb			*9200 *22,250	*9200 *22,250	*7400 *15,900	6500 13,950	*5450 *11,700	4050 8700	*4450 *9600	2750 5800	3400 7200	1900 4000	*1500 *3250	1400 3050	10.46 34.33
Ground Line	kg lb			*6500 *14,850	*6500 *14,850	*8800 *19,000	5950 12,800	*6250 *13,500	3800 8100	4550 9750	2600 5500	3300 *6950	1800 3850	*1650 *3650	1450 3150	10.18 33.40
-1.5 m -5.0 ft	kg lb	*4400 *9800	*4400 *9800	*8200 *18,650	*8200 *18,650	*9500 *20,550	5700 12,200	6400 13,700	3600 7700	4450 9500	2500 5300			*2000 *4350	1600 3500	9.61 31.50
-3.0 m -10.0 ft	kg lb	*7200 *16,100	*7200 *16,100	*11 450 *26,100	11 300 24,200	*9450 *20,450	5600 12,050	6350 13,550	3550 7600	4400 9450	2450 5250			*2550 *5600	1950 4300	8.69 28.40
-4.5 m -15.0 ft	kg lb	*10 700 *24,100	*10 700 *24,100	*12 800 *27,500	11 600 24,850	*8600 *18,500	5700 12,250	*6150 *13,100	3600 7750					*3650 *8250	2750 6150	7.27 23.56
-6.0 m -20.0 ft	kg lb			*9400 *19,800	*6350 *13,100	*9400 *19,800	6000 12,950							*4800 *10,550	4550 10,550	5.37 17.15

* Indicates that the load is limited by hydraulic capacity rather than tipping capacity. Lift capacity ratings are based on SAE standard J1097. Rated loads do not exceed 87% of hydraulic lifting capacity or 75% of tipping capacity.

Reach Boom Lift Capacities

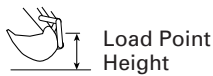

Load at
Maximum Reach



Load Radius
Over Front















Load Radius
Over Side

R2.5B STICK – 2500 mm (8'2")
BUCKET – 1.0 m³ (1.3 yd³)

UNDERCARRIAGE – Standard
SHOES – 600 mm (24") triple grouser

BOOM – 5680 mm (18'7")













	3.0 m (10.0 ft)		4.5 m (15.0 ft)		6.0 m (20.0 ft)		7.5 m (25.0 ft)				m ft	
												
7.5 m 25.0 ft	kg lb									*2450 *5400	*2450 *5400	7.24 23.39
6.0 m 20.0 ft	kg lb					*4350 *9450	4000 8600			*2300 *5050	2150 4800	8.34 27.17
4.5 m 15.0 ft	kg lb					*4900 *10,600	3850 8300	4000 8550	2500 5350	*2300 *5000	1800 3950	8.97 29.34
3.0 m 10.0 ft	kg lb			*7500 *16,050	5850 12,550	*5650 *12,250	3650 7800	3900 8300	2450 5150	*2350 *5200	1600 3550	9.25 30.32
1.5 m 5.0 ft	kg lb			8750 18,800	5300 11,400	5500 11,750	3400 7300	3800 8100	2350 4950	*2550 *5600	1550 3450	9.22 30.27
Ground Line	kg lb			8400 18,050	5000 10,750	5300 11,350	3250 6950	3700 7900	2250 4800	2800 6100	1650 3600	8.89 29.17
-1.5 m -5.0 ft	kg lb	*9150 *20,900	*9150 20,750	8350 17,850	4950 10,600	5200 11,200	3150 6800	3650 8050	2200 4850	3200 7000	1900 4200	8.21 26.90
-3.0 m -10.0 ft	kg lb	*12 700 *27,550	9950 21,300	8450 18,100	5050 10,800	5250 11,300	3200 6900			4150 9200	2550 5650	7.07 23.04
-4.5 m -15.0 ft	kg lb	*9800 *20,850	*9800 *20,850	*6900 *14,550	5300 11,350					*5400 *11,800	4100 9300	5.32 17.16

* Indicates that the load is limited by hydraulic capacity rather than tipping capacity. Lift capacity ratings are based on SAE standard J1097. Rated loads do not exceed 87% of hydraulic lifting capacity or 75% of tipping capacity.

R2.5B STICK – 2500 mm (8'2")
BUCKET – 1.0 m³ (1.3 yd³)

UNDERCARRIAGE – Long
SHOES – 800 mm (32") triple grouser

BOOM – 5680 mm (18'7")

	3.0 m (10.0 ft)		4.5 m (15.0 ft)		6.0 m (20.0 ft)		7.5 m (25.0 ft)				m ft	
												
7.5 m 25.0 ft	kg lb									*2450 *5400	*2450 *5400	7.24 23.39
6.0 m 20.0 ft	kg lb					*4350 *9450	*4350 *9450			*2300 *5050	*2300 *5050	8.34 27.17
4.5 m 15.0 ft	kg lb					*4900 *10,600	4450 9600	*4450 *9700	2950 6300	*2300 *5000	2150 4700	8.97 29.34
3.0 m 10.0 ft	kg lb			*7500 *16,050	6750 14,550	*5650 *12,250	4250 9100	*4800 *10,350	2850 6100	*2350 *5200	1950 4250	9.25 30.32
1.5 m 5.0 ft	kg lb			*9000 *19,400	6250 13,400	*6450 *13,950	4000 8600	4700 *10,100	2750 5900	*2550 *5600	1900 4150	9.22 30.27
Ground Line	kg lb			*9750 *21,100	5950 12,750	6650 14,250	3850 8200	4650 9900	2700 5700	*2850 *6300	2000 4400	8.89 29.17
-1.5 m -5.0 ft	kg lb	*9150 *20,900	*9150 *20,900	*9750 *21,050	5850 12,550	6550 14,050	3750 8050	4600 *10,100	2650 5850	*3400 *7500	2300 5050	8.21 26.90
-3.0 m -10.0 ft	kg lb	*12 700 *27,550	11 900 25,500	*8950 *19,350	5950 12,750	*6500 *13,900	3800 8150			*4350 *9500	3000 6700	7.07 23.04
-4.5 m -15.0 ft	kg lb	*9800 *20,850	*9800 *20,850	*6900 *14,550	6200 13,350					*5400 *11,800	4800 10,900	5.32 17.16

* Indicates that the load is limited by hydraulic capacity rather than tipping capacity. Lift capacity ratings are based on SAE standard J1097. Rated loads do not exceed 87% of hydraulic lifting capacity or 75% of tipping capacity.

JC Machinery **SUNIGHT**

excavatorhunter.com

Reach Boom Lift Capacities



Load Point Height



Load at Maximum Reach



Load Radius Over Front



Load Radius Over Side

R2.9B STICK – 2900 mm (9'7")
BUCKET – 1.0 m³ (1.3 yd³)

UNDERCARRIAGE – Standard
SHOES – 600 mm (24") triple grouser

BOOM – 5680 mm (18'7")

Load Point Height	1.5 m (5.0 ft)		3.0 m (10.0 ft)		4.5 m (15.0 ft)		6.0 m (20.0 ft)		7.5 m (25.0 ft)		m ft		
	Over Front	Over Side	Over Front	Over Side	Over Front	Over Side	Over Front	Over Side	Over Front	Over Side	kg	lb	
7.5 m 25.0 ft											*1800 *3950	*1800 *3950	7.76 25.11
6.0 m 20.0 ft									*3300 *7300	2650 5850	*1700 *3700	*1700 *3700	8.77 28.62
4.5 m 15.0 ft							*4550 *9800	3950 8400	4050 8600	2550 5450	*1700 *3700	1650 3600	9.37 30.66
3.0 m 10.0 ft			*11 250 *23,850	*11 250 *23,850	*6950 *14,900	5950 12,850	*5350 *11,550	3700 7950	3950 8400	2450 5250	*1750 *3800	1500 3250	9.64 31.60
1.5 m 5.0 ft					*8600 *18,550	5400 11,650	5550 11,850	3450 7400	3800 8150	2350 5000	*1900 *4150	1450 3150	9.61 31.54
Ground Line			*5200 *12,000	*5200 *12,000	8500 18,200	5050 10,900	5300 11,400	3250 7000	3700 7900	2250 4800	*2150 *4700	1500 3300	9.30 30.50
-1.5 m -5.0 ft	*5200 *11,600	*5200 *11,600	*8800 *20,050	*8800 *20,050	8350 17,850	4950 10,600	5200 11,150	3150 6750	3650 7800	2200 4700	*2550 *5600	1700 3750	8.66 28.36
-3.0 m -10.0 ft	*9150 *20,500	*9150 *20,500	*13 550 *29,250	9850 21,100	8400 17,950	5000 10,700	5200 11,200	3150 6800			*3300 *7300	2200 4900	7.60 24.79
-4.5 m -15.0 ft			*11 000 *23,550	10 250 22,000	*7700 *16,350	5150 11,100					*3900 *8650	3450 7600	5.97 19.59

* Indicates that the load is limited by hydraulic capacity rather than tipping capacity. Lift capacity ratings are based on SAE standard J1097. Rated loads do not exceed 87% of hydraulic lifting capacity or 75% of tipping capacity.

R2.9B STICK – 2900 mm (9'7")
BUCKET – 1.0 m³ (1.3 yd³)

UNDERCARRIAGE – Long
SHOES – 800 mm (32") triple grouser

BOOM – 5680 mm (18'7")

Load Point Height	1.5 m (5.0 ft)		3.0 m (10.0 ft)		4.5 m (15.0 ft)		6.0 m (20.0 ft)		7.5 m (25.0 ft)		m ft		
	Over Front	Over Side	Over Front	Over Side	Over Front	Over Side	Over Front	Over Side	Over Front	Over Side	kg	lb	
7.5 m 25.0 ft											*1800 *3950	*1800 *3950	7.76 25.11
6.0 m 20.0 ft									*3300 *7300	3100 6800	*1700 *3700	*1700 *3700	8.77 28.62
4.5 m 15.0 ft							*4550 *9800	*4550 9700	*4200 *9100	3000 6400	*1700 *3700	*1700 *3700	9.37 30.66
3.0 m 10.0 ft			*11 250 *23,850	*11 250 *23,850	*6950 *14,900	6900 14,850	*5350 *11,550	4300 9250	*4550 *9950	2900 6150	*1750 *3800	*1750 *3800	9.63 31.60
1.5 m 5.0 ft					*8600 *18,550	6350 13,650	*6200 *13,400	4050 8700	4750 10,150	2800 5950	*1900 *4150	1750 3850	9.61 31.54
Ground Line			*5200 *12,000	*5200 *12,000	*9600 *20,750	6000 12,850	6650 14,300	3850 8250	4650 9900	2700 5700	*2150 *4700	1850 4000	9.30 30.50
-1.5 m -5.0 ft	*5200 *11,600	*5200 *11,600	*8800 *20,050	*8800 *20,050	*9800 *21,200	5850 12,550	6550 14,050	3750 8050	4550 9800	2650 5600	*2550 *5600	2100 4550	8.66 28.36
-3.0 m -10.0 ft	*9150 *20,500	*9150 *20,500	*13 550 *29,250	11 800 25,300	*9250 *20,000	5900 12,650	6550 14,050	3750 8050			*3300 *7300	2650 5850	7.60 24.79
-4.5 m -15.0 ft			*11 000 *23,550	*11 000 *23,550	*7700 *16,350	6100 13,100					*3900 *8650	3900 *8650	5.97 19.59

* Indicates that the load is limited by hydraulic capacity rather than tipping capacity. Lift capacity ratings are based on SAE standard J1097. Rated loads do not exceed 87% of hydraulic lifting capacity or 75% of tipping capacity.

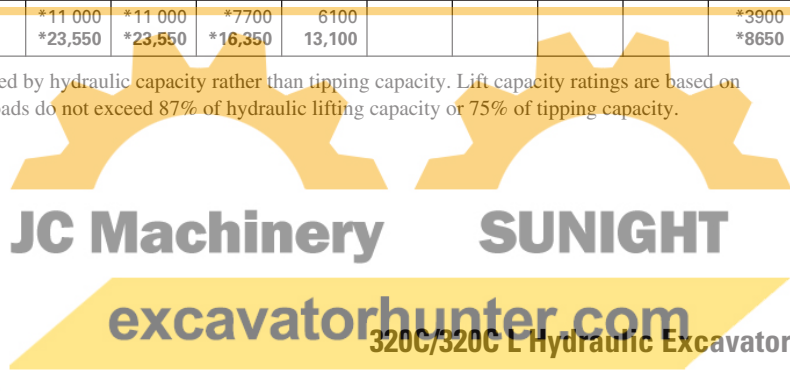

Mass Boom Lift Capacities

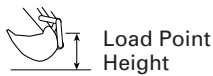

Load at
Maximum Reach



Load Radius
Over Front

















Load Radius
Over Side

M2.4C STICK – 2400 mm (7'10")
BUCKET – 1.3 m³ (1.7 yd³)

UNDERCARRIAGE – Standard
SHOES – 600 mm (24") triple grouser

BOOM – 5200 mm (17'1")















	1.5 m (5.0 ft)		3.0 m (10.0 ft)		4.5 m (15.0 ft)		6.0 m (20.0 ft)		7.5 m (25.0 ft)				m ft	
														
7.5 m 25.0 ft	kg lb											*2950 *2950	6.57	
6.0 m 20.0 ft	kg lb						*4300 *9350	3800 8150				*2750 *6000	2250 5000	7.79 25.37
4.5 m 15.0 ft	kg lb						*4850 *10,500	3600 7650				*2700 *5950	1750 3900	8.47 27.71
3.0 m 10.0 ft	kg lb					*7150 *15,350	5700 12,300	*5500 11,850	3400 7300	3600 7950	2150 4700	2750 6000	1550 3400	8.76 28.72
1.5 m 5.0 ft	kg lb					*8650 18,600	5200 11,150	5300 11,300	3200 6800	3500 7450	2050 4300	2700 5900	1500 3300	8.71 28.60
Ground Line	kg lb			*7450 *17,200	*7450 *17,200	8300 17,750	4850 10,400	5100 10,900	3000 6450			2900 6300	1600 3550	8.33 27.32
-1.5 m -5.0 ft	kg lb	*7250 *16,250	*7250 *16,250	*13,350 *30,450	9500 20,300	8200 17,550	4750 10,200	5000 10,750	2950 6300			3450 7600	2000 4400	7.55 24.71
-3.0 m -10.0 ft	kg lb			*12,200 *26,300	9800 21,000	8300 17,800	4850 10,400	5100 11,250	3050 6700			*3150 *6850	3000 6650	6.20 20.16

* Indicates that the load is limited by hydraulic capacity rather than tipping capacity. Lift capacity ratings are based on SAE standard J1097. Rated loads do not exceed 87% of hydraulic lifting capacity or 75% of tipping capacity.

M2.4C STICK – 2400 mm (7'10")
BUCKET – 1.3 m³ (1.7 yd³)

UNDERCARRIAGE – Long
SHOES – 800 mm (32") triple grouser

BOOM – 5200 mm (17'1")

	1.5 m (5.0 ft)		3.0 m (10.0 ft)		4.5 m (15.0 ft)		6.0 m (20.0 ft)		7.5 m (25.0 ft)				m ft	
														
7.5 m 25.0 ft	kg lb											*2950 *2950	6.52	
6.0 m 20.0 ft	kg lb						*4300 *9400	*4300 9400				*2750 *6050	2700 6000	7.75 25.23
4.5 m 15.0 ft	kg lb						*4850 *10,500	4200 8950				*2750 *6050	2150 4750	8.43 27.57
3.0 m 10.0 ft	kg lb					*7150 *15,350	6650 14,300	*5500 *11,950	4000 8600	4550 9950	2550 5600	*2850 *6300	1900 4200	8.72 28.59
1.5 m 5.0 ft	kg lb					*8650 *18,650	6100 13,150	*6250 *13,500	3800 8100	4450 9500	2500 5250	*3150 *6900	1850 4100	8.67 28.46
Ground Line	kg lb			*7450 *17,200	*7450 *17,200	*9500 *20,450	5750 12,400	6450 13,800	3600 7750			*3600 *7900	2000 4400	8.29 27.20
-1.5 m -5.0 ft	kg lb	*7250 *16,250	*7250 *16,250	*13,350 *30,450	11,450 24,500	*9450 *20,400	5700 12,150	6350 13,650	3550 7600			4400 9700	2450 5350	7.51 24.60
-3.0 m -10.0 ft	kg lb			*12,200 *26,300	11,800 25,200	*8400 *18,000	5800 12,400	*5600 *12,350	3650 8000			*3700 *7900	3550 *7900	6.17 20.05

* Indicates that the load is limited by hydraulic capacity rather than tipping capacity. Lift capacity ratings are based on SAE standard J1097. Rated loads do not exceed 87% of hydraulic lifting capacity or 75% of tipping capacity.

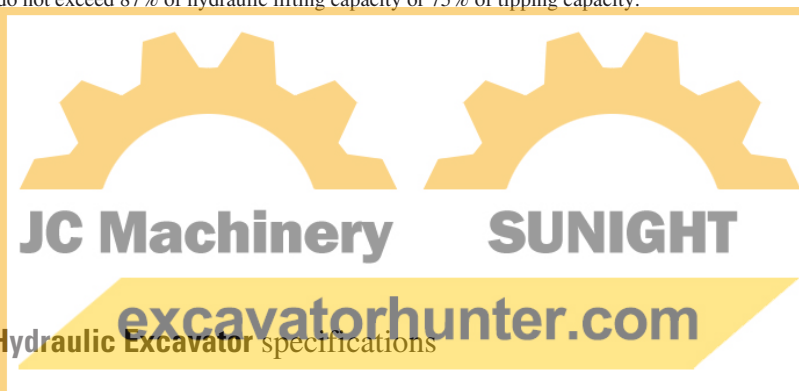

Standard Equipment

Standard equipment may vary. Consult your Caterpillar dealer for details.

Alternator, 50 amp

Automatic engine speed control

Automatic swing brake

Auxiliary hydraulic valve (1)

Cab

AM/FM radio with speakers

Ash tray with cigar lighter

Bi-level air conditioner with defroster

Coat hook

Drink holder

Fully adjustable suspension seat

Heater and defroster

Horn

Hydraulic neutralizer lever for all controls

Language display monitor with gauges

Clock

Filter/fluid change information

Level check for hydraulic oil, engine oil and coolant

Warning messages

Working hour information

Light, interior

Literature holder

Openable front windshield

Openable skylight with sunshade

Positive filtered ventilation

Pre-wired for Product Link

Retractable seatbelt

Storage compartment

Travel control pedals with removable hand levers

Power train

Cat 3066T diesel engine

24-volt electric starting

Air intake heater

Water separator

Undercarriage

Hydraulic track adjusters

Track type undercarriage with grease lubricated seals

Idler and center section track guiding guards

800 mm (32 in) triple grouser shoes

Mirrors (frame and cab)

Door locks and caps locks with one-key security system

Bolt-on FOGS capability

Automatic work modes

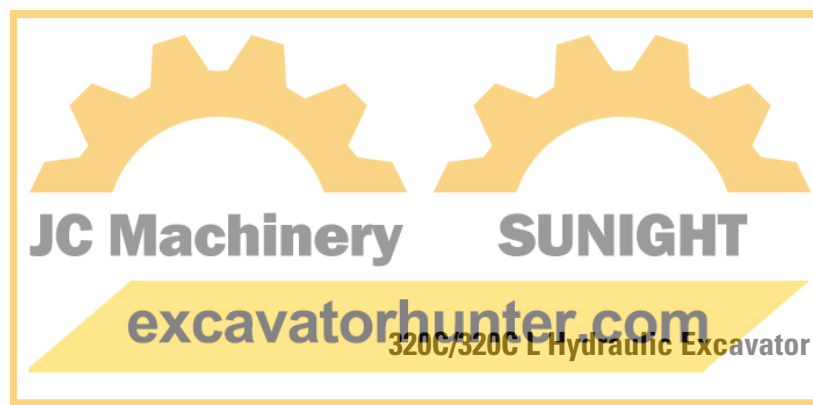

Optional Equipment

Optional equipment may vary. Consult your Caterpillar dealer for details.

Air prefilter
Auxiliary hydraulic lines from booms and sticks
Boom lowering control device - (mandatory in certain countries)
Bucket linkage (B family - reach; C family - mass)
Cab mounted working lights
Cab with polycarbonate windows - (mandatory in certain countries)
Cold weather start
Electric refueling pump
Falling Object Guards
Fine swing control
Front windshield guard
Hammer circuit
Hand control pattern changer
Heavy duty bottom guard
High ambient cooling system
Lower windshield wiper
Power supply 12V-7A
Quick Coupler, Hydraulic Pin Grabber, factory installed
Right side boom lights
Rubber bumpers
Seat with suspension, headrest and joystick height adjustment
Secondary exit, rear window - (mandatory in certain countries)
Stick and Boom combinations:
 Reach boom - 5.68 m (18 ft 7 in), std. and special application
 3.9 m (12 ft 8 in) R3.9B stick
 2.9 m (9 ft 7 in) R2.9B stick
 2.9 m (9 ft 7 in) R2.9B SA stick
 2.5 m (8 ft 2 in) R2.5B stick
 2.5 m (8 ft 2 in) R2.5B SA stick
 Mass boom - 5.20 m (17 ft 1 in)
 2.4 m (7 ft 9 in) M2.4C stick
 Long reach arrangement
 Boom - 8.85 m (29 ft)
 Stick - 6.28 m (20 ft 1 in)
 Bucket linkage
 25% heavier counterweight

Straight travel pedal
Sun visor
Swivel guard
Thumb circuit
Tool Control System
Track:
 600 mm (24 in) triple grouser shoes
 700 mm (28 in) triple grouser shoes
 600 mm (24 in) double grouser shoes
Track guiding guard
Travel alarm - (mandatory in certain countries)
Vandalism protection
Water separator with indicator

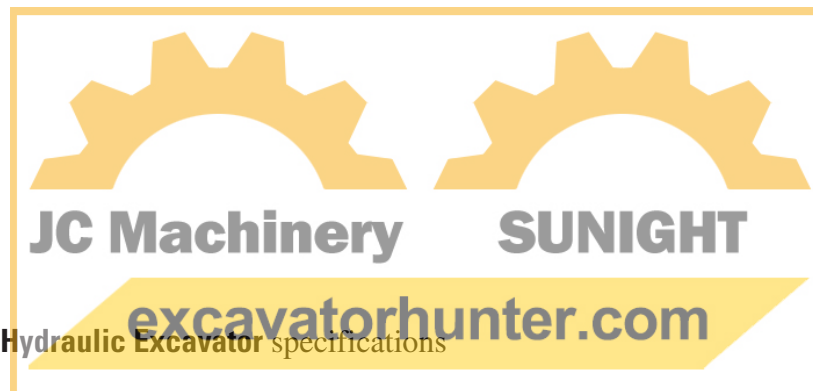

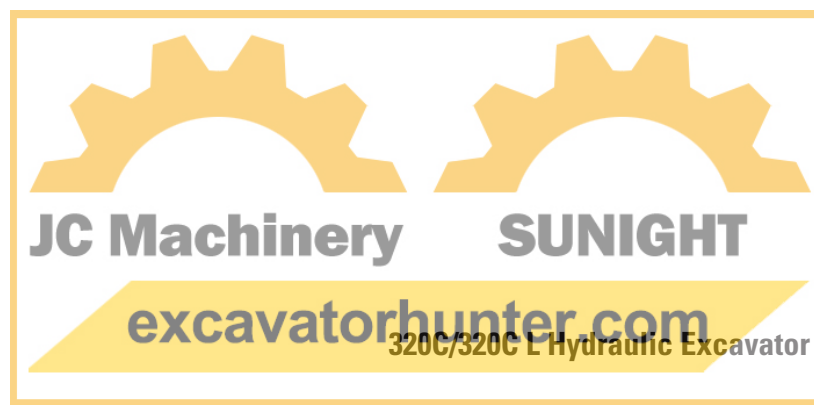

320C/320C L Hydraulic Excavator

AEHQ9051 (2-03)

NACD, LACD (Replaces AEHQ5393-02)

For more complete information on Cat products, dealer services,
and industry solutions, visit us on the web at www.CAT.com

© 2003 Caterpillar
Printed in U.S.A.

Materials and specifications are subject to change without notice.
Featured machines in photos may include additional equipment.
See your Caterpillar dealer for available options.



CATERPILLAR[®]