

# 325D/ 325D L

Hydraulic Excavator

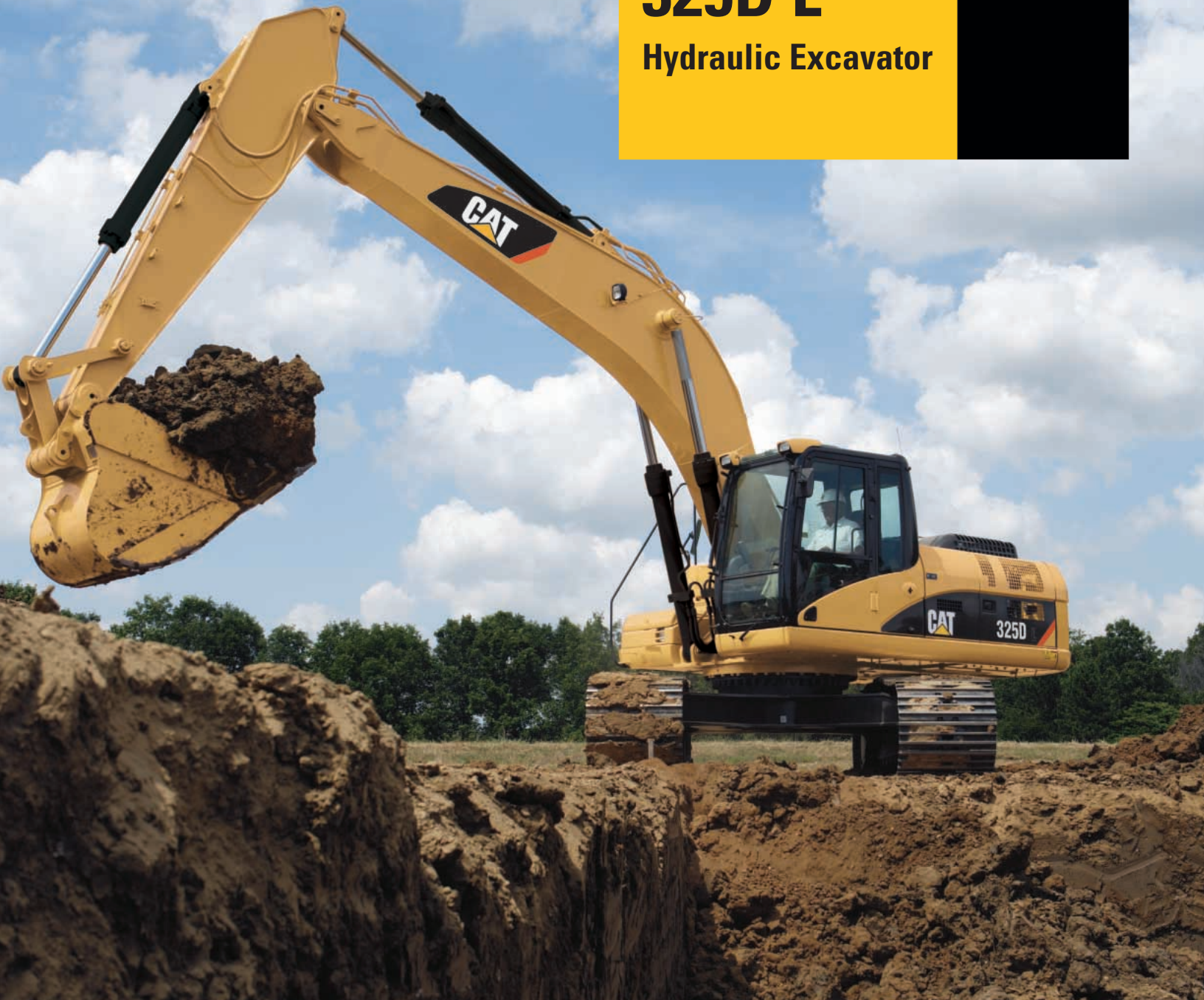

**JC Machinery**

[excavatorhunter.com](http://excavatorhunter.com)

## Engine

Engine Model	Cat® C7 with ACERT™ Technology
Net Flywheel Power	140 kW      188 hp

## Weights

Operating Weight – Std. Undercarriage	26 900 kg	59,300 lb
Operating Weight – Long Undercarriage	29 240 kg	64,500 lb

# 325D/325D L Hydraulic Excavator

*The D Series incorporates innovations for improved performance and versatility.*

---

## Engine

- ✓ The Cat® C7 with ACERT™ Technology offers better fuel consumption and reduced wear. It works at the point of combustion to optimize performance and provide low exhaust emissions. By combining ACERT Technology with the new Economy Mode and Power Management, customers can balance the demands of performance and fuel economy to suit their requirements and application. **pg. 4**

---

## Hydraulics

The hydraulic system has been designed to provide reliability and outstanding controllability. An optional Tool Control System provides enhanced flexibility. **pg. 5**

---

## Operator Station

- ✓ Provides maximum space, wider visibility and easy access to switches. The monitor is a full-color graphical display that allows the operator to understand the machine information easily. Overall, the new cab provides a comfortable environment for the operator. **pg. 6**

---

## Service and Maintenance

Fast, easy service has been designed in with extended service intervals, advanced filtration, convenient filter access and user-friendly electronic diagnostics for increased productivity and reduced maintenance costs. **pg. 12**

---

## Complete Customer Support

Your Cat® dealer offers a wide range of services that can be set up under a customer support agreement when you purchase your equipment. The dealer will help you choose a plan that can cover everything from machine configuration to eventual replacement. **pg. 13**



**JC Machinery**      **SUNIGHT**  
**excavatorhunter.com**

---

**Structures**

Caterpillar design and manufacturing techniques assure outstanding durability and service life from these important components. **pg. 8**

---

**Booms and Sticks**

Three lengths of booms and five sticks are available to suit a variety of application conditions. **pg. 9**

---

**Work Tools – Attachments**

- ✓ A variety of work tools, including buckets, couplers, hammers, and shears are available through Cat Work Tools. **pg. 10**



**JC Machinery**

**SUNIGHT**

✓ *New Feature*

**excavatorhunter.com**

## Engine

*The Cat® C7 gives the 325D exceptional power and fuel efficiency unmatched in the industry for consistently high performance in all applications.*

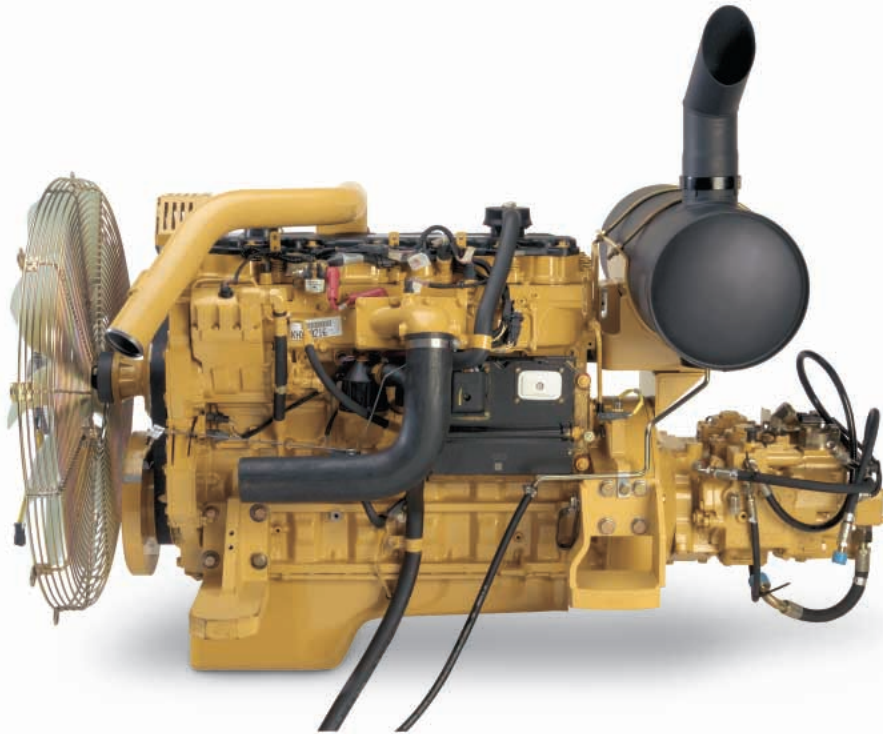

**Cat C7.** The Cat C7 with ACERT™ Technology introduces a series of evolutionary, incremental improvements that provide breakthrough engine technology. The building blocks of ACERT Technology are fuel delivery, air management and electronic control. ACERT Technology optimizes engine performance while meeting EU Stage II engine emission regulations for off-road applications. By combining ACERT Technology with the new Economy Mode and Power Management, customers can balance the demands of performance and fuel economy to suit their requirements and application.

**Performance.** The Cat C7 with ACERT Technology offers more power, and runs at lower speeds for better fuel efficiency and reduced wear. The 325D is available with two power versions:

- Standard power (140 kW)
- Optional High power (152 kW)

### **Automatic Engine Speed Control.**

The two-stage, one-touch control maximizes fuel efficiency and reduces sound levels.

### **ADEM™ A4 Engine Controller.**

The ADEM A4 electronic control module manages fuel delivery to get the best performance per liter of fuel used.

The engine management system provides flexible fuel mapping, allowing the engine to respond quickly to varying application needs. It tracks engine and machine conditions while keeping the engine operating at peak efficiency.

**Fuel Delivery.** The Cat C7 features electronic controls that govern the fuel injection system. Multiple injection fuel delivery involves a high degree of precision. Precisely shaping the combustion cycle lowers combustion chamber temperatures, generating fewer emissions and optimizing fuel combustion. This translates into more work output for your fuel cost.

### **Flexible Fuel Options.**

**Economy Mode.** Available as standard, economy mode is best utilized in light duty applications and offers the best fuel economy while maintaining the breakout forces and lift capacity enjoyed while in standard power mode.

**Power Management.** Included in the optional high power (152 kW) setting. Power Management optimizes machine performance for each type of application. The operator can change the engine power on the monitor (password protected) from standard to high. The high power mode is recommended for extremely productive and hard digging applications. The standard power mode is recommended for lighter duty applications and optimizes fuel efficiency.

**Cooling System.** The cooling fan is directly driven from the engine. An electrically controlled viscous clutch fan is available as an attachment to reduce fan noise. The optimum fan speed is calculated based on the target engine speed, coolant temperature, hydraulic oil temperature and actual fan speed. The Cat C7 delivered a completely new layout that separates the cooling system from the engine compartment.

**Air Cleaner.** The radial seal air filter features a double-layered filter core for more efficient filtration and is located in a compartment behind the cab. A warning is displayed on the monitor when dust accumulates above a preset level.

### **Noise Reduction Technologies.**

The engine mounts are rubber-isolating mounts matched with the engine package. Further noise reduction has been achieved through design changes to the isolated top cover, oil pan, multiple injection strategy, insulated timing cover, sculpted crankcase and gear train refinements.

JC Machinery SUNIGHT  
excavatorhunter.com

## Hydraulics

*Cat hydraulics delivers power and precise control to keep material moving.*

**Component Layout.** The 325D hydraulic system and component locations have been designed to provide a high level of system efficiency. The main pumps, control valves and hydraulic tank are located close together to allow for shorter tubes and lines between components that reduce friction loss and pressure drops in the lines. The layout further provides greater operator comfort by placing the radiator on the cab side of the upper structure. This allows incoming air to enter the engine compartment from the operator side and hot air and corresponding engine sound to exit on the opposite side away from the operator. This reduces engine compartment heat and sound being transmitted to the operator.

**Pilot System.** The pilot pump is independent from the main pumps and controls the front linkage, swing and travel operations.

### **Hydraulic Cross Sensing System.**

The hydraulic cross sensing system utilizes each of two hydraulic pumps to 100 percent of engine power, under all operating conditions. This improves productivity with faster implement speeds and quicker, stronger pivot turns.

### **Boom and Stick Regeneration Circuit.**

Boom and stick regeneration circuit saves energy during boom-down and stick-in operation which increases efficiency, reduces cycle times and pressure loss for higher productivity, lower operating costs and increased fuel efficiency.



**Auxiliary Hydraulic Valve.** The auxiliary valve is standard on the 325D. Control Circuits are available as attachments, allowing for operation of high and medium pressure tools such as shears, grapples, hammers, pulverizers, multi-processors and vibratory plate compactors.

### **Hydraulic Cylinder Snubbers.**

Snubbers are located at the rod-end of the boom cylinders and both ends of the stick cylinders to cushion shocks while reducing sound levels and extending component life.

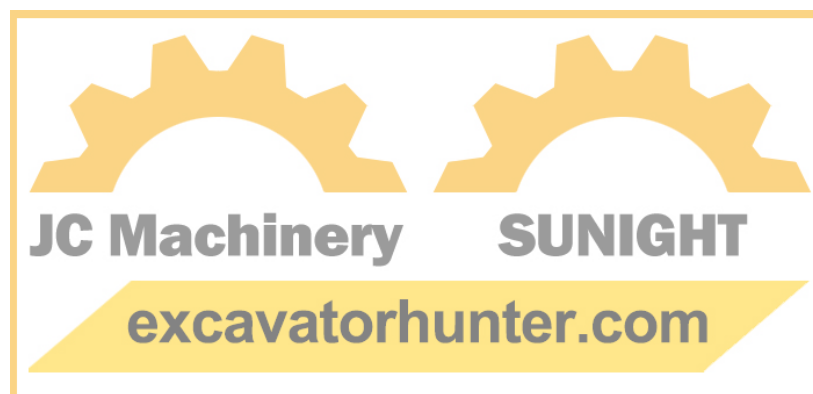

## Operator Station

*Designed for comfort, simple and easy operation, the 325D allows the operator to focus on production.*



**JC Machinery**

**SUNIGHT**

**excavatorhunter.com**

**Operator Station.** The workstation is spacious, quiet and comfortable, assuring high productivity during a long workday. The air conditioner and attachment switches are conveniently located on the right-hand wall, and the key switch and throttle dial are on the right-hand console. The monitor is mounted in front of the right front cab post and is easy to see.

**Standard Cab Equipment.** To enhance operator comfort and productivity, the cab includes a lighter; drink holder, coat hook, service meter, literature holder, magazine rack and storage compartment.



**Monitor.** The monitor is a full color 400x234 pixels Liquid Crystal Display (LCD) graphic display. The monitor angle can be adjusted to minimize sun glare and has the capability of displaying information in twenty-seven different languages.

The Master Caution Lamp blinks ON and OFF when one of the critical conditions below occurs:

- Engine oil pressure low
- Coolant temperature high
- Hydraulic oil temperature high

Under normal conditions or the default condition, the monitor display screen is divided into four areas; clock and throttle dial, gauge, event display and multi-information display.

**Clock and Throttle Dial Display.**

The clock and throttle dial position are displayed in this area. When Economy mode/Power management system is activated, the icon of the gas station icon will be indicated at the side of the throttle dial.

**Gauge Display.** Three analog gauges, fuel level, hydraulic oil temperature and coolant temperature, are displayed in this area.

**Event Display.** Machine information is displayed in this area with the icon and language.

**Multi-information Display.** This area is reserved for displaying various information that is convenient for the operator. The “CAT” logo mark is displayed when no information is available to be displayed.

**Joystick Control.** Joystick controls have low lever effort and are designed to match the operator’s natural wrist and arm position. The operator can operate joystick controls with an arm on the armrest and the horizontal and vertical strokes have been designed to reduce operator fatigue.

**Seat.** A new optional air suspension seat is available in the 325D. The standard and optional seats provide a variety of adjustments to suit the operator’s size and weight including fore/aft, height and weight. Wide adjustable armrests and a retractable seat belt are also included.

**Hydraulic Activation Control Lever.**

For added safety, this lever must be in the operate position to activate the machine control functions.

**Climate Control.** Positive filtered ventilation with a pressurized cab is standard. Fresh air or re-circulated air can be selected with a switch on the left console.



**Console.** Redesigned consoles feature a simple, functional design to reduce operator fatigue, ease of switch operation and excellent visibility. Both consoles have attached armrests with height adjustments.

**Cab Exterior.** The exterior design uses thick steel tubing along the bottom perimeter of the cab, improving the resistance of fatigue and vibration. This design allows the FOGS to be bolted directly to the cab, at the factory or as an attachment later, enabling the machine to meet specifications and job site requirements.

**Cab Mounts.** The cab shell is attached to the frame with viscous rubber cab mounts, which dampen vibrations and sound levels while enhancing operator comfort.

**Windows.** To promote visibility, all glass is affixed directly to the cab, eliminating window frames. The upper front windshield opens, closes and stores on the roof above the operator with a one-touch action release system.

**Wipers.** Pillar-mounted wipers increase the operator’s viewing area and offer continuous and intermittent modes.

**Skylight.** An enlarged skylight with sunshade provides excellent visibility and excellent ventilation.

**Product Link.** Product Link is now an attachment available from the factory.

## Structures

*325D structural components and undercarriage are the backbone of the machine's durability.*

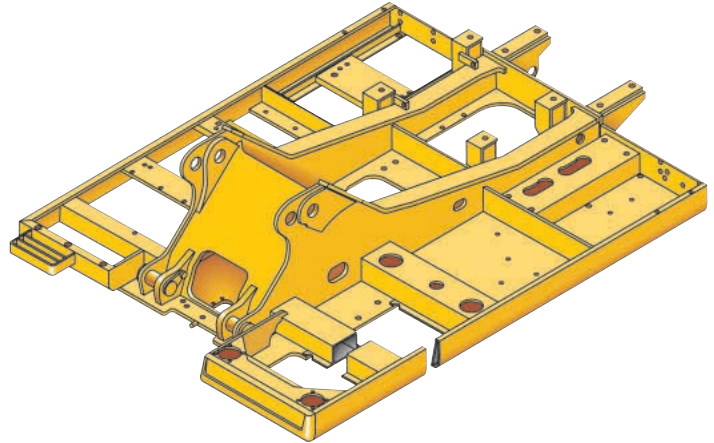
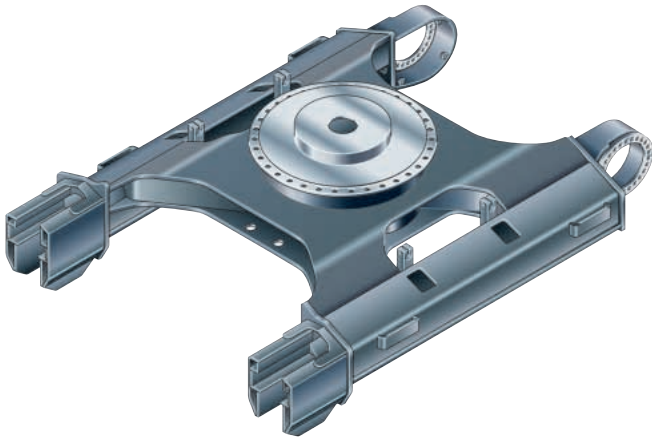

**Robotic Welding.** Up to 95% of the structural welds on a Caterpillar® Excavator are completed by robots. Robotic welds achieve over three times the penetration of manual welds.

**Carbody Design and Track Roller Frames.** X-shaped, box-section carbody provides excellent resistance to torsion bending. Robot-welded track roller frames are press-formed, pentagonal units to deliver exceptional strength and service life.

**Main Frame.** Rugged main frame is designed for maximum durability and efficient use of materials.

**Undercarriage.** Durable Cat undercarriage absorbs stresses and provides excellent stability.

**Rollers and Idlers.** Sealed and lubricated track rollers, carrier rollers, and idlers provide excellent service life, to keep the machine in the field longer.

**Standard Undercarriage.** The standard undercarriage is well suited for applications that require frequent repositioning of the machine, have restricted working space or uneven, rocky terrain.

**Long Undercarriage.** The long (L) undercarriage maximizes stability and lift capacity. This long, wide, and sturdy undercarriage offers a very stable work platform.



**JC Machinery**

**SUNIGHT**

**excavatorhunter.com**



## Booms and Sticks

*Designed-in flexibility to help bring higher production and efficiency to all jobs.*

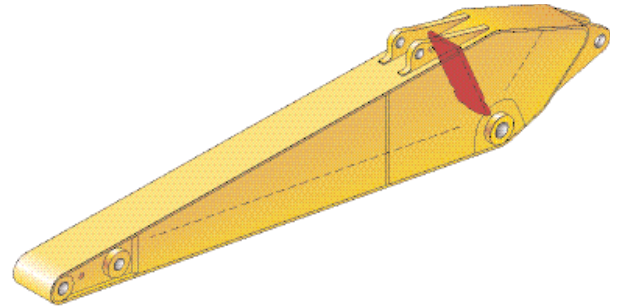
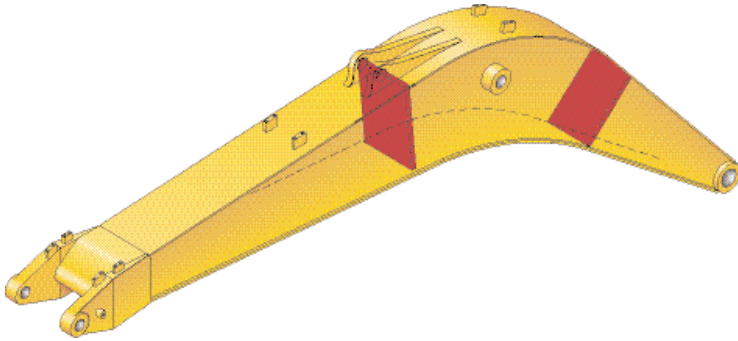

### **Booms, Sticks and Attachments.**

Designed for maximum flexibility, productivity and high efficiency on all jobs, the 325D offers a wide range of configurations suitable for a variety of applications.

**Front Linkage Attachments.** Three lengths of booms and five types of sticks are available, offering a range of configurations suitable for a wide variety of application conditions.

**Booms.** The booms have large cross-sections and internal baffle plates to provide long life durability.

**Sticks.** The sticks are made of high-tensile strength steel using a large box section design with interior baffle plates and an additional bottom guard.

**Reach Boom.** The reach boom features an optimum design that maximizes digging envelopes with two stick choices:

R3.2CB and R3.0CB Sticks

- The CB-family bucket associated with these sticks have enough capacity for excellent reach and depth in trenching and general construction applications.

R2.65CB Stick

- Stick is suited to high-capacity buckets used in trenching, excavation, and other general construction work. It has been designed with enough reach and depth to match a large-capacity bucket and high digging force.

**Heavy-Duty Reach Boom.** Heavy-duty reach boom provides additional strength recommended for tough applications.

R2.65CB Heavy Duty Stick

- The R2.65CB HD Stick is special reinforced version of the R2.65CB stick for use with the Heavy-duty Reach Boom.

**Mass Excavation Boom.** The mass excavation boom maximizes productivity. The mass version offers significantly higher digging forces and allows use of larger buckets.

M2.5DB and M3.0DB Sticks

- The DB Stick uses a D-family bucket and was designed for high volume earth moving, powerful digging force and a large capacity bucket. Combined with a Mass boom, this stick delivers outstanding productivity.

**Linkage Pins.** The bucket linkage pins have been enlarged to improve reliability and durability. All the pins in the front linkages have thick chrome plating, giving them high wear and corrosion resistance.

**Bucket Linkage.** The power link improves durability, increases machine-lifting capability in key lifting positions and is easier to use than compared to the previous lifting eye.



## Work Tools – Attachments

The 325D has an extensive selection of work tools to optimize machine performance.

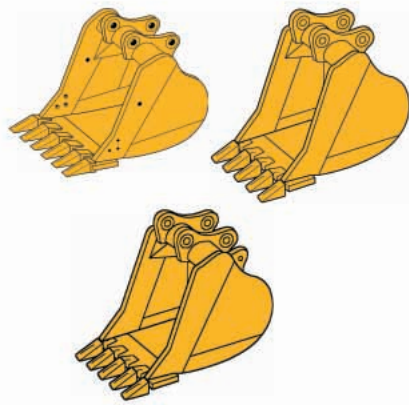

**Service Life.** Caterpillar® buckets increase service life and reduce repair costs.

- Dual radius design for increased heel clearance and reduced wear
- Robot welding of hinge assembly for increased weld penetration and longer life
- Incorporates the new aggressive and easier to install, K Series™ GET system
- High strength and heat-treated steel that exceeds T-1 in high wear areas

**Excavation Buckets (X).** Excavation (X) buckets for digging in low-impact, moderately abrasive materials such as dirt, loam, gravel and clay.

**Heavy-Duty Buckets.** Heavy-duty (HD) buckets are used for a wide range of moderately abrasive applications such as mixed dirt, clay and rock. HD buckets have best loading and dumping characteristics and will empty easier in cohesive material. More robust construction than the GP buckets.

### Heavy-Duty Power (HDP) Buckets.

For use in moderately abrasive applications where breakout force and cycle times are critical. Maximizes tip force and improves cycle times in most materials. Not for use in sticky material conditions. Cutting edge and GET are up-sized.

**Heavy-Duty Rock Buckets.** Heavy-duty rock for aggressive bucket loading in highly abrasive application such as shot rock and granite. Features include:

- Thicker wear plates to extend the life of bucket in severe applications
- Side wear plated extend further up the side of the bucket for maximum protection in rocky soils
- Buckets accept sidebar protectors for best sidebar protection, or side cutters for best fill characteristics and bucket wear protection

### Caterpillar Ground Engaging Tools (GET).

The new Caterpillar K Series GET is featured on the new buckets. This new GET system uses a vertical retainer that is easier to remove and install than the Cat J Series pin. The new tooth shapes are more aggressive and offer better penetration than the previous generation of tips. There are also a variety of side cutters and sidebar protectors to match operating conditions.



**Tool Control System.** The tool control system maximizes work tool productivity by configuring hydraulic flow, pressure, and operator controls to match a specific work tool. System versatility enables a wide range of tools to be used.



## Versatility

*A wide variety of optional factory-installed attachments to enhance performance and improve job site management.*



*Hammer*

Cat Hydraulic Hammers are precisely matched to Cat machines for optimum performance in a wide variety of demolition and construction applications.



*Thumb*

Cat® thumbs multiply the capacities of your excavator. This highly versatile tool works in conjunction with the bucket to transform an excavator into a versatile material-handling machine.



*Multi-processor*

Multi-processors do the work of many types of demolition tools by use of interchangeable jaw sets. Changing jaws allows a single unit to crush, pulverize and perform a variety of specialized cutting tasks, such as cutting steel rebar and tanks.



*Vibratory Plate Compactor*

Caterpillar® Vibratory Plate Compactors provide superior compaction force in a reliable, low-maintenance package. These units produce high-power impulses at a rate of 2,200 impacts per minute. The forces generated by this vibration drive soil particles close together for solid, stable compactions. Whether in a trench or on a slope, driving sheeting or posts, Cat Compactors are the superior choice for any jobsite's compaction tasks.



*360° Scrap Shear*

Caterpillar Scrap Shears feature 360° rotation and high force-to-weight ratio. Used for demolishing steel structures and preparing bulk scrap (such as cars, farm machinery and railroad cars) for further processing.



*Pin-Grabber Quick Coupler*

Pin-Grabber Plus Quick Couplers multiply the versatility and utility of Cat Excavators by allowing them to pick up and use virtually any work tool equipped with standard pins.

**Dedicated Quick Coupler.** Quick Couplers increase the versatility of Cat excavators; allowing the ease of changing work tools to meet job requirements at hand in a matter of minutes or seconds. Dedicated quick coupler buckets have no loss of tip radius, and develop maximum breakout force.

## Service and Maintenance

*Simplified service and maintenance features save you time and money.*



**Ground Level Service.** The design and layout of the 325D was made with the service technician in mind. Many service locations are easily accessible at ground level allowing critical maintenance to get done quickly and efficiently.

**Air Filter Compartment.** The air filter features a double-element construction for superior cleaning efficiency. When the air cleaner plugs, a warning is displayed on the monitor screen inside the cab.

**Pump Compartment.** A service door on the right side of the upper structure allows ground-level access to the pump and pilot filter.

**Radiator Compartment.** The left rear service door allows easy access to the engine radiator, oil cooler and air-to-air-after-cooler. A reserve tank and drain cock are attached to the radiator for simplified maintenance.

**Capsule Filter.** The hydraulic return filter, a capsule filter, is situated outside the hydraulic tank. This filter prevents contaminants from entering the system when hydraulic oil is changed and keeps the operation clean.

**Greasing Points.** A concentrated remote greasing block on the boom delivers grease to hard-to-reach locations on the front.

**Fan Guard.** Engine radiator fan is completely enclosed by fine wire mesh, reducing the risk of an accident.

**Anti-Skid Plate.** Anti-skid plate covers top of storage box and upper structure to prevent slipping during maintenance.



**Diagnostics and Monitoring.** The 325D is equipped with S•O•S<sup>SM</sup> sampling ports and hydraulic test ports for the hydraulic system, engine oil, and for coolant. A test connection for the Cat Electronic Technician (Cat ET) service tool is located in the cab.

**Extended Service Interval.** 325D service and maintenance intervals have been extended to reduce machine service time and increase machine availability.

JC Machinery SUNIGHT  
excavatorhunter.com

## Complete Customer Support

*Cat dealer services help you operate longer with lower costs.*



**Product Support.** You will find nearly all parts at our dealer parts counter. Cat dealers utilize a worldwide computer network to find in-stock parts to minimize machine down time. Save money with remanufactured components.

**Machine Selection.** Make detailed comparisons of the machines you are considering before you buy. What are the job requirements, machine attachments and operating hours? What production is needed? Your Cat dealer can provide recommendations.

**Purchase.** Look past initial price. Consider the financing options available as well as day-to-day operating costs. This is also the time to look at dealer services that can be included in the cost of the machine to yield lower equipment owning and operating costs over the long run.

**Customer Support Agreements.** Cat dealers offer a variety of product support agreements, and work with customers to develop a plan the best meets specific needs. These plans can cover the entire machine, including attachments, to help protect the customer's investment.

**Operation.** Improving operating techniques can boost your profits. Your Cat dealer has videotapes, literature and other ideas to help you increase productivity, and Caterpillar offers certified operator training classes to help maximize the return on your investment.

**Maintenance Services.** Repair option programs guarantee the cost of repairs up front. Diagnostic programs such as Scheduled Oil Sampling, Coolant Sampling and Technical Analysis help you avoid unscheduled repairs.

**Replacement.** Repair, rebuild, or replace? Your Cat dealer can help you evaluate the cost involved so you can make the right choice.

**JC Machinery**      **SUNIGHT**

**excavatorhunter.com**

## Engine

Engine Model	Cat C7 with ACERT Technology	
Net Flywheel Power	140 kW	188 hp
Net Power – ISO 9249	140 kW	188 hp
Bore	110 mm	4.3 in
Stroke	127 mm	5 in
Displacement	7.2 L	440 in <sup>3</sup>

- The 325D/325D L meets low exhaust emissions equivalent to former USA EPA Tier 2 and EU Stage II engine emissions regulations.
- Net power advertised is the power available at the flywheel when the engine is equipped with fan, air cleaner, muffler and alternator.
- No engine derating needed up to 2300 m (7,500 ft).

## Weights

Operating Weight – Std. Undercarriage	26 900 kg	59,300 lb
Operating Weight – Long Undercarriage	29 240 kg	64,500 lb

- Reach boom, R3.2CB2 (10 ft 5 in) Stick, 1.1 m<sup>3</sup> (1.44 yd<sup>3</sup>) Bucket, 600 mm (24 in) Shoes
- Reach boom, R3.2CB2 (10 ft 5 in) Stick, 1.1 m<sup>3</sup> (1.44 yd<sup>3</sup>) Bucket, 800 mm (32 in) Shoes

## Track

Standard w/Standard Undercarriage	600 mm	24 in
Standard w/Long Undercarriage	800 mm	32 in
Optional	600 mm	24 in
Optional	700 mm	28 in
Optional	800 mm	32 in

## Swing Mechanism

Swing Speed	10.2 rpm	
Swing Torque	82.2 kN·m	60,628 lb ft

## Drive

Maximum Drawbar Pull	249 kN	55,977 lb
Maximum Travel Speed	5.3 km/h	3.3 mph

## Hydraulic System

Main Implement System – Maximum Flow (2x)	235 L/min	62 gal/min
Max. Pressure – Equipment	35 000 kPa	5,076 psi
Max. Pressure – Travel	35 000 kPa	5,076 psi
Max. Pressure – Swing	27 500 kPa	3,988 psi
Pilot System – Maximum Flow	32.4 L/min	8.56 gal/min
Pilot System – Maximum Pressure	3900 kPa	566 psi
Boom Cylinder – Bore	140 mm	5.51 in
Boom Cylinder – Stroke	1407 mm	55 in
Stick Cylinder – Bore	150 mm	5.91 in
Stick Cylinder – Stroke	1646 mm	65 in
CB1 Family Bucket Cylinder – Bore	135 mm	5.3 in
CB1 Family Bucket Cylinder – Stroke	1156 mm	46 in
DB Family Bucket Cylinder – Bore	150 mm	5.91 in
DB Family Bucket Cylinder – Stroke	1156 mm	46 in

## Service Refill Capacities

Fuel Tank Capacity	520 L	137 gal
Cooling System	30 L	7.9 gal
Engine Oil	30 L	7.9 gal
Swing Drive	10 L	2.6 gal
Final Drive (each)	6 L	1.6 gal
Hydraulic System (including tank)	310 L	82 gal
Hydraulic Tank	145 L	38 gal

## Sound Performance

Performance	ANSI/SAE
-------------	----------

- When properly installed and maintained, the cab offered by Caterpillar, when tested with doors and windows closed according to ANSI/SAE J1166 OCT 98, meets OSHA and MSHA requirements for operator sound exposure limits in effect at time of manufacture.
- Hearing protection may be needed when operating with an open operator station and cab (when not properly maintained or doors/windows open) for extended periods or in noisy environment.

## Standards

Brakes	SAE J1026 APR90
Cab/FOGS	SAE J1356 FEB88 ISO 10262

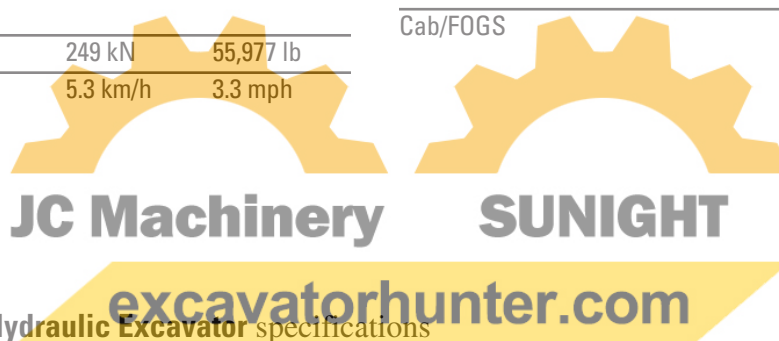

# Dimensions

All dimensions are approximate.

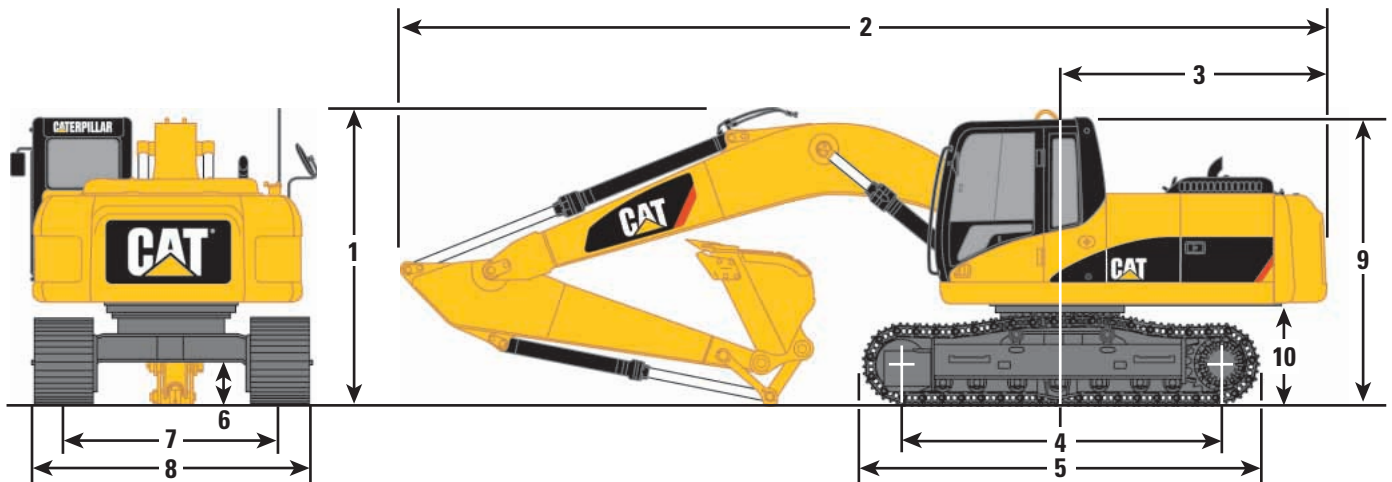

Boom Options	Reach — 6.15 m (20'2")			Mass — 5.55 m (18'2")	
Stick Options	R3.2CB2 (10'6")	R3.0CB2 (9'10")	R2.65CB2 (8'8")	M3.2CB2 (10'6")	M2.5DB (8'2")
1 Shipping height**	3180 mm (10'5")	3130 mm (10'3")	3190 mm (10'6")	3130 mm (10'3")	3250 mm (10'8")
2 Shipping length	10 410 mm (34'2")	10 400 mm (34'1")	10 420 mm (34'2")	9800 mm (32'2")	9860 mm (32'4")
3 Tail swing radius	3080 mm (10'1")	3080 mm (10'1")	3080 mm (10'1")	3080 mm (10'1")	3080 mm (10'1")
Undercarriage	Fixed Gauge		Long Fixed Gauge		
4 Length to centers of rollers	3490 mm (11'5")		3990 mm (13'1")		
5 Track length	4360 mm (14'4")		4860 mm (15'11")		
6 Ground clearance***	490 mm (1'7")		490 mm (1'7")		
7 Track gauge	2390 mm (7'10")		2590 mm (8'6")		
8 Shipping width*	2990 mm (9'10")		3190 mm (10'6")		
9 Cab height**	3040 mm (9'12")		3040 mm (9'12")		
10 Counterweight clearance***	1110 mm (3'8")		1110 mm (3'8")		

\* Track width shown is for 600 mm (24") track shoes.

\*\* Includes 30 mm shoe lug height.

\*\*\* Without 30 mm shoe lug height.

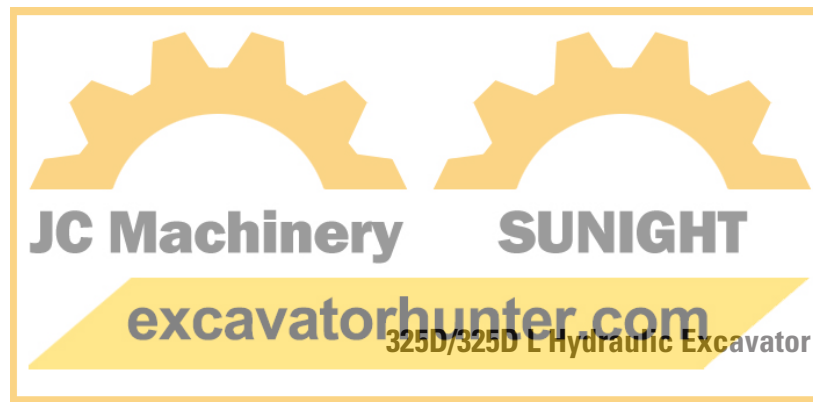

## Reach Excavator Working Ranges

Reach (R) boom configuration

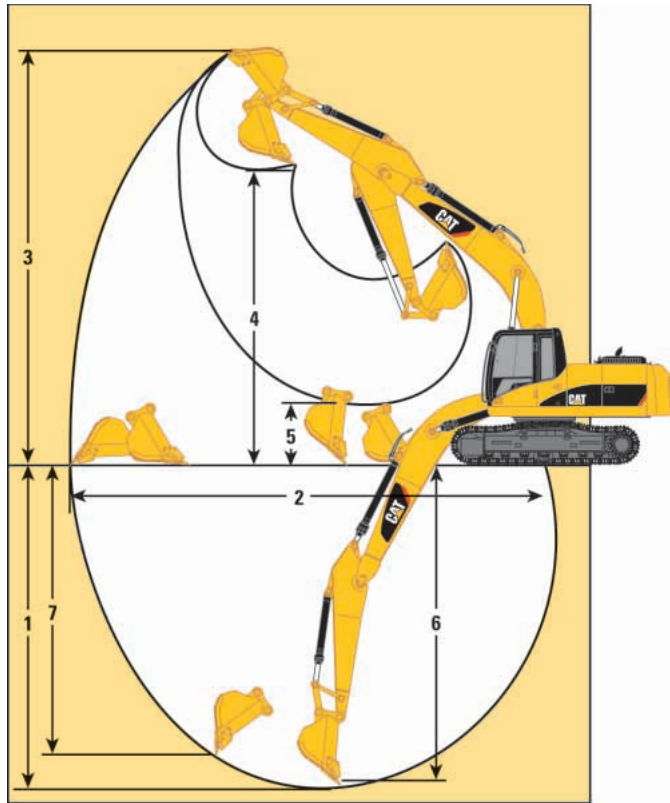

## Mass Excavator Working Ranges

Mass (M) boom configuration

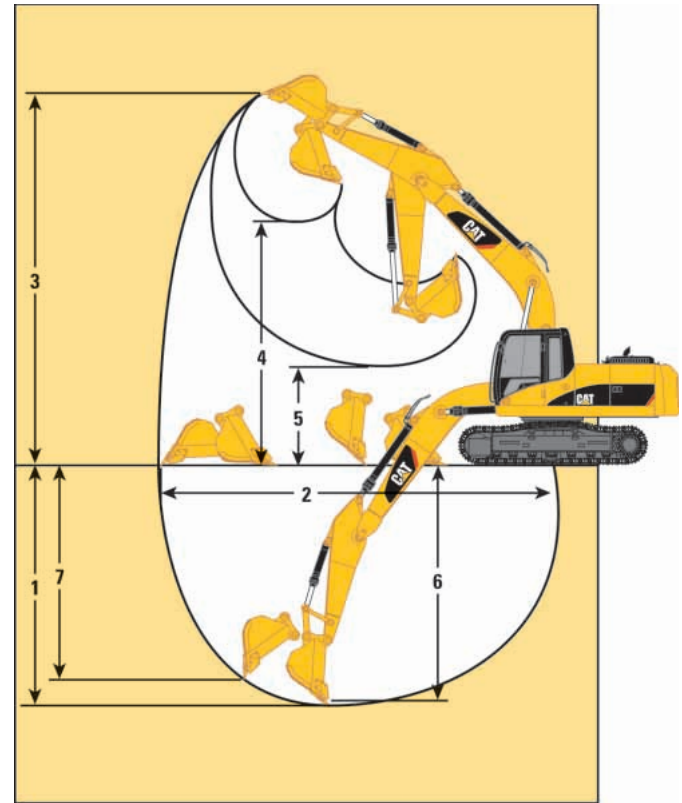

### Boom Options

Stick Options	Reach — 6.15 m (20'2")			Mass — 5.55 m (18'2")	
	R3.2CB2 (10'6")	R3.0CB2 (9'10")	R2.65CB2 (8'8")	M3.2CB2 (10'6")	M2.5DB (8'2")
1 Maximum digging depth	7170 mm (23'6")	6970 mm (22'10")	6620 mm (21'9")	6630 mm (21'9")	6010 mm (19'9")
2 Maximum reach at ground level	10 600 mm (34'9")	10 410 mm (34'2")	10 130 mm (33'3")	9970 mm (32'9")	9340 mm (30'8")
3 Maximum cutting height	9990 mm (32'9")	9900 mm (32'6")	9880 mm (32'5")	9560 mm (31'4")	9150 mm (30'0")
4 Maximum loading height	7020 mm (23'0")	6930 mm (22'9")	6870 mm (22'6")	6590 mm (21'7")	6090 mm (19'11")
5 Minimum loading height	2370 mm (7'9")	2570 mm (8'5")	2920 mm (9'7")	1940 mm (6'4")	2560 mm (8'5")
6 Maximum depth cut for 2440 mm (8') level bottom	7010 mm (22'11")	6810 mm (22'4")	6440 mm (21'2")	6470 mm (21'3")	5810 mm (19'1")
7 Maximum vertical wall digging depth	6510 mm (21'4")	6310 mm (20'8")	5980 mm (19'7")	5960 mm (19'7")	4710 mm (15'5")
Bucket digging force (ISO)	188 kN (42,264 lb)	188 kN (42,264 lb)	188 kN (42,264 lb)	188 kN (42,264 lb)	222 kN (49,908 lb)
(SAE)	166 kN (37,318 lb)	166 kN (37,318 lb)	166 kN (37,318 lb)	166 kN (37,318 lb)	198 kN (44,512 lb)
Stick digging force (ISO)	128 kN (28,776 lb)	134 kN (30,124 lb)	147 kN (33,047 lb)	128 kN (28,776 lb)	155 kN (34,845 lb)
(SAE)	124 kN (27,876 lb)	130 kN (29,225 lb)	142 kN (31,923 lb)	124 kN (27,876 lb)	150 kN (33,721 lb)

JC Machinery SUNIGHT

excavatorhunter.com



# Major Component Weights

	kg	lb
Base machine with counterweight and 600 mm (24") shoes (without front linkage)	21 620	47,663
Two boom cylinders	548	1,209
Counterweight		
Standard Machine	5410	11,927
Boom (includes lines, pins and stick cylinder)		
Reach boom	2299	5,068
Mass boom	2374	5,234
Stick (includes lines, pins, bucket cylinder and linkage)		
R3.2CB2	1392	3,070
R2.65CB2	1299	2,865
M3.2DB	1530	3,374
M2.5DB	1455	3,207
Track roller frame [includes frame, rollers, idlers, steps, guards, final drive, 600 mm (24") shoes] – each	9440	20,811

## 325D Bucket Specifications and Compatibility

	Capacity*		Width		Tip Radius		Weight (w/o tips)		Teeth Qty	Total Weight		Reach Stick				Mass Stick	
	m <sup>3</sup>	yd <sup>3</sup>	mm	in	mm	in	kg	lb		kg	lb	R3.2CB2	R3.0CB2	R2.65CB2	R2.0DB	M3.2CB2	M2.5DB
<b>CB2 Buckets</b>																	
Excavation	1.1	1.44	1320	52	1555	61.2	857	1,890	5	857	1,890	●	●	●	—	●	—
	1.2	1.57	1420	56	1555	61.2	896	1,970	5	896	1,970	●	●	●	—	●	—
Heavy Duty	1.3	1.70	1390	55	1578	62.1	1033	2,280	6	1033	2,280	○	●	●	—	●	—
Mass Excavation	1.5	1.96	1600	63	1578	62.1	1035	2,280	6	1035	2,280	○	●	●	—	○	—
<b>DB Buckets</b>																	
Excavation	1.4	1.83	1470	58	1660	65.4	1101	2,430	5	1101	2,430	—	—	—	●	—	●
	1.5	1.96	1560	61	1660	65.4	1144	2,520	5	1144	2,520	—	—	—	●	—	●
Mass Excavation	1.6	2.09	1540	61	1660	65.4	1191	2,620	6	1191	2,620	—	—	—	●	—	○

## 325D L Bucket Specifications and Compatibility

	Capacity*		Width		Tip Radius		Weight (w/o tips)		Teeth Qty	Total Weight		Reach Stick				Mass Stick	
	m <sup>3</sup>	yd <sup>3</sup>	mm	in	mm	in	kg	lb		kg	lb	R3.2CB2	R3.0CB2	R2.65CB2	R2.0DB	M3.2CB2	M2.5DB
<b>CB2 Buckets</b>																	
Excavation	1.1	1.44	1320	52	1555	61.2	857	1,890	5	857	1,890	●	●	●	—	●	—
	1.2	1.57	1420	56	1555	61.2	896	1,970	5	896	1,970	●	●	●	—	●	—
Heavy Duty	1.3	1.70	1390	55	1578	62.1	1033	2,280	6	1033	2,280	●	●	●	—	●	—
Mass Excavation	1.5	1.96	1600	63	1578	62.1	1035	2,280	6	1035	2,280	●	●	●	—	●	—
<b>DB Buckets</b>																	
Excavation	1.4	1.83	1470	58	1660	65.4	1101	2,430	5	1101	2,430	—	—	—	●	—	●
	1.5	1.96	1560	61	1660	65.4	1144	2,520	5	1144	2,520	—	—	—	●	—	●
Mass Excavation	1.6	2.09	1540	61	1660	65.4	1191	2,620	6	1191	2,620	—	—	—	●	—	●

Assumptions for maximum material density rating:

1. Front linkage fully extended at ground line
2. Bucket curled
3. 100% bucket fill factor

\* Based on SAE J296, some calculations of capacity specs fall on borderlines. Rounding may allow two buckets to have the same English rating, but different metric ratings.

- 2100 kg/m<sup>3</sup> (3,500 lb/yd<sup>3</sup>) max material density
- ◐ 1800 kg/m<sup>3</sup> (3,000 lb/yd<sup>3</sup>) max material density
- 1500 kg/m<sup>3</sup> (2,500 lb/yd<sup>3</sup>) max material density
- ∴ 1200 kg/m<sup>3</sup> (2,000 lb/yd<sup>3</sup>) max material density
- Not Available



## 325D/325D L Work Tool Matching Guide

Boom Options	Reach Boom 6.15 m (20'2")			Mass Boom 5.55 m (18'2")	
Stick Options	R3.2CB2 (10'6")	R3.0CB2 (9'10")	R2.65CB2 (8'8")	M3.2CB2 (10'6")	M2.5DB (8'2")
Hydraulic Hammer	H120Cs/ H130Cs/ H140Cs	H120Cs/ H130Cs/ H140Cs	H120Cs/ H130Cs/ H140Cs	H120Cs/ H130Cs/ H140Cs	H120Cs/ H130Cs/ H140Cs
Vibratory Plate Compactor	CVP110	CVP110	CVP110	CVP110	CVP110
Multi-Processor	MP15/MP20	MP15/MP20	MP15/MP20	n/a	n/a
360 Scrap Shear	S320	S320	S320/S325	n/a	n/a
Trash Grapple	3.1 m <sup>3</sup> /4 yd <sup>3</sup>	3.1 m <sup>3</sup> /4 yd <sup>3</sup>	3.1 m <sup>3</sup> /4 yd <sup>3</sup>	4.6 m <sup>3</sup> /6.02 yd <sup>3</sup>	4.6 m <sup>3</sup> /6.02 yd <sup>3</sup>
Contractors' Grapple	yes	yes	yes	n/a	n/a
Hydraulic Thumb	yes	yes	yes	n/a	n/a
Dedicated Quick Coupler	yes	yes	yes	yes	yes
Pin-Grabber Quick Coupler	yes	yes	yes	yes	yes

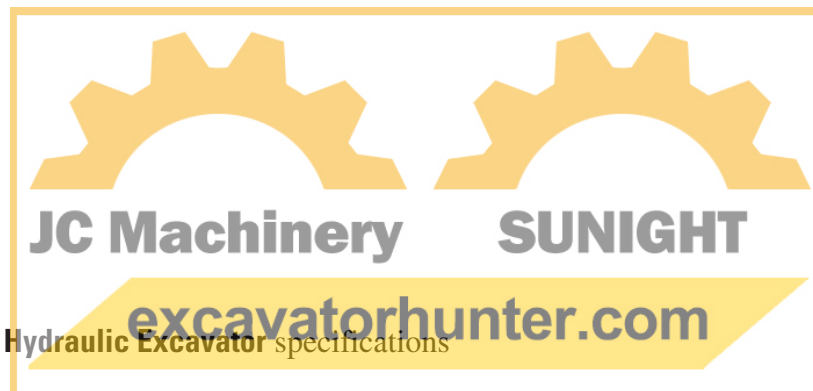

# Reach Boom Lift Capacities



Load Point Height



Load Radius Over Front



Load Radius Over Side















Load at Maximum Reach

**R2.65CB2 STICK** – 2650 mm (8'9")  
**BUCKET** – 1.3 m<sup>3</sup> (1.70 yd<sup>3</sup>)

**UNDERCARRIAGE** – Long  
**SHOES** – 600 mm (24") triple grouser

**BOOM** – 6150 mm (20'3")













		3.0 m (10.0 ft)		4.5 m (15.0 ft)		6.0 m (20.0 ft)		7.5 m (25.0 ft)		9.0 m (30.0 ft)				m ft
														
7.5 m 25.0 ft	kg lb											*3500 *7,750	*3500 *7,750	8.34 27.06
6.0 m 20.0 ft	kg lb							*6550 *14,350	4650 9,900			*3400 *7,450	3200 7,100	9.21 30.07
4.5 m 15.0 ft	kg lb					*7850 *17,000	6800 14,550	*6950 *15,200	4550 9,750			*3400 *7,450	2800 6,150	9.72 31.82
3.0 m 10.0 ft	kg lb			*12 500 *26,850	10 050 21,650	*9250 *19,950	6400 13,700	7250 15,550	4400 9,400			*3500 *7,700	2600 5,700	9.93 32.56
1.5 m 5.0 ft	kg lb			*14 850 *32,000	9250 19,950	10 200 21,850	6000 12,900	7050 15,100	4200 9,000	5150 3050		*3750 *8,250	2550 5,650	9.86 32.37
Ground Line	kg lb			*15 800 *34,200	8900 19,150	9900 21,250	5750 12,350	6900 14,800	4050 8,700			*4150 *9,150	2700 5,950	9.52 31.24
-1.5 m -5.0 ft	kg lb	*8950 *20,350	*8950 *20,350	*15 650 *33,950	8850 18,950	9800 21,000	5650 12,100	6850 14,650	4000 8,600			*4850 *10,650	3100 6,800	8.87 29.07
-3.0 m -10.0 ft	kg lb	*15 700 *35,800	*15 700 *35,800	*14 550 *31,450	8950 19,250	9850 21,100	5700 12,200	6900	4050			*6000 *13,300	3900 8,600	7.83 25.54
-4.5 m -15.0 ft	kg lb	*16 500 *35,450	*16 500 *35,450	*12 050 *25,800	9250 19,950	*8650 *18,050	5950 12,800					*7800 *17,150	5500 12,350	6.32 20.50

\* Limited by hydraulic capacity rather than tipping load. The above loads are in compliance with SAE hydraulic excavator lift capacity rating standard J1097. They do not exceed 87% of hydraulic lifting capacity or 75% of tipping capacity. Weight of all lifting accessories must be deducted from the above lifting capacities.

**R3.0CB2 STICK** – 3000 mm (9'11")  
**BUCKET** – 1.2 m<sup>3</sup> (1.57 yd<sup>3</sup>)

**UNDERCARRIAGE** – Long  
**SHOES** – 600 mm (24") triple grouser

**BOOM** – 6150 mm (20'3")

		1.5 m (5.0 ft)		3.0 m (10.0 ft)		4.5 m (15.0 ft)		6.0 m (20.0 ft)		7.5 m (25.0 ft)		9.0 m (30.0 ft)				m ft	
																	
7.5 m 25.0 ft	kg lb													*3000 *6,650	*3000 *6,650	8.68 28.20	
6.0 m 20.0 ft	kg lb									*6250 *13,550	4800 10,200			*2950 *6,450	*2950 *6,450	9.52 31.08	
4.5 m 15.0 ft	kg lb							*7450 *16,200	6900 14,850	*6700 *14,600	4650 10,000			*2950 *6,450	2700 6,000	10.00 32.77	
3.0 m 10.0 ft	kg lb					*11 850 *25,450	10 250 22,100	*8900 *19,200	6500 13,950	7350 15,750	4450 9,550	5350 *10,800	3200 6,800	*3050 *6,750	2550 5,550	10.21 33.48	
1.5 m 5.0 ft	kg lb					*14 400 *31,000	9400 20,300	*10 250 *22,050	6100 13,050	7100 15,250	4250 9,150	5250 11,200	3100 6,600	*3300 *7,250	2500 5,500	10.14 33.29	
Ground Line	kg lb			*4900 *11,250	*4900 *11,250	*15 700 *33,900	8950 19,250	9950 21,350	5800 12,450	6950 14,850	4100 8,800	5150 3050		*3650 *8,050	2600 5,750	9.82 32.21	
-1.5 m -5.0 ft	kg lb	*5750 *12,900	*5750 *12,900	*9250 *21,000	*9250 *21,000	*15 800 *34,250	8850 18,950	9800 21,000	5650 12,150	6850 14,700	4000 8,600			*4250 *9,400	2950 6,450	9.19 30.11	
-3.0 m -10.0 ft	kg lb	*10 350 *23,200	*10 350 *23,200	*14 850 *33,750	*14 850 *33,750	*14 950 *32,350	8900 19,150	9800 21,050	5650 12,150	6900 14,800	4050 8,700			*5300 *11,800	3600 8,000	8.19 26.76	
-4.5 m -15.0 ft	kg lb			*17 950 *38,550	*17 950 *38,550	*12 850 *27,600	9150 19,700	*9400 *20,000	5850 12,600						*4750 *10,700	*4750 *10,700	6.63 21.47

\* Limited by hydraulic capacity rather than tipping load. The above loads are in compliance with SAE hydraulic excavator lift capacity rating standard J1097. They do not exceed 87% of hydraulic lifting capacity or 75% of tipping capacity. Weight of all lifting accessories must be deducted from the above lifting capacities.

**JC Machinery SUNIGHT**

**excavatorhunter.com**

325D/325D L Hydraulic Excavator specifications

# Reach Boom Lift Capacities



Load Point Height



Load Radius Over Front



Load Radius Over Side



















Load at Maximum Reach

**R3.2CB2 STICK** – 3200 mm (10'6")  
**BUCKET** – 1.2 m<sup>3</sup> (1.57 yd<sup>3</sup>)

**UNDERCARRIAGE** – Long  
**SHOES** – 600 mm (24") triple grouser

**BOOM** – 6150 mm (20'3")

















		1.5 m (5.0 ft)		3.0 m (10.0 ft)		4.5 m (15.0 ft)		6.0 m (20.0 ft)		7.5 m (25.0 ft)		9.0 m (30.0 ft)				m ft
																
7.5 m 25.0 ft	kg lb									*4500 *4500				*2800 *6,150	*2800 *6,150	8.91 28.95
6.0 m 20.0 ft	kg lb									*6000 *13,100	4800 10,300			*2700 *5,950	*2700 *5,950	9.72 31.75
4.5 m 15.0 ft	kg lb							*7200 *15,600	6950 14,900	*6500 *14,150	4700 10,050	*4450 *7,950	3250 6,950	*2750 *6,000	2600 5,750	10.19 33.39
3.0 m 10.0 ft	kg lb					*11 400 *24,500	10 400 22,350	*8650 *18,650	6550 14,000	*7250 *15,750	4500 9,600	5350 11,450	3200 6,800	*2850 *6,250	2450 5,350	10.39 34.09
1.5 m 5.0 ft	kg lb					*14 050 *30,300	9500 20,450	*10 050 *21,700	6100 13,100	7100 15,250	4250 9,150	5250 11,200	3100 6,600	*3050 *6,700	2400 5,250	10.33 33.91
Ground Line	kg lb			*5200 *11,950	*5200 *11,950	*15 550 *33,600	9000 19,300	9950 21,350	5800 12,450	6950 14,850	4100 8,750	5150 11,050	3000 6,450	*3400 *7,450	2500 5,500	10.01 32.85
-1.5 m -5.0 ft	kg lb	*5550 *12,450	*5550 *12,450	*9050 *20,550	*9050 *20,550	*15 850 *34,300	8800 18,950	9800 20,950	5650 12,100	6800 14,650	4000 8,550			*3950 *8,700	2800 6,150	9.40 30.81
-3.0 m -10.0 ft	kg lb	*9750 *21,900	*9750 *21,900	*14 150 *32,150	*14 150 *32,150	*15 150 *32,700	8850 19,050	9750 20,950	5650 12,100	6850 14,700	4000 8,600			*4900 *10,900	3400 7,600	8.43 27.55
-4.5 m -15.0 ft	kg lb			*18 650 *40,150	*18 650 *40,150	*13 250 *28,400	9100 19,550	*9700 *20,700	5800 12,450					*5150 *11,000	4850 10,950	6.94 22.46

\* Limited by hydraulic capacity rather than tipping load. The above loads are in compliance with SAE hydraulic excavator lift capacity rating standard J1097. They do not exceed 87% of hydraulic lifting capacity or 75% of tipping capacity. Weight of all lifting accessories must be deducted from the above lifting capacities.

**R3.2CB2 STICK** – 3200 mm (10'6")  
**BUCKET** – 1.2 m<sup>3</sup> (1.57 yd<sup>3</sup>)

**UNDERCARRIAGE** – Long  
**SHOES** – 800 mm (32") triple grouser

**BOOM** – 6150 mm (20'3")

		1.5 m (5.0 ft)		3.0 m (10.0 ft)		4.5 m (15.0 ft)		6.0 m (20.0 ft)		7.5 m (25.0 ft)		9.0 m (30.0 ft)				m ft
																
7.5 m 25.0 ft	kg lb									*4500 *4500				*2800 *6,150	*2800 *6,150	8.91 28.95
6.0 m 20.0 ft	kg lb									*6000 *13,100	5000 10,650			*2700 *5,950	*2700 *5,950	9.72 31.75
4.5 m 15.0 ft	kg lb							*7200 *15,600	7150 15,400	*6500 *14,150	4850 10,400	*4450 *7,950	3400 7,200	*2750 *6,000	2700 *6,000	10.19 33.39
3.0 m 10.0 ft	kg lb					*11 400 *24,500	10 700 23,050	*8650 *18,650	6750 14,500	*7250 *15,750	4650 9,950	5550 *11,850	3350 7,100	*2850 *6,250	2550 5,600	10.39 34.09
1.5 m 5.0 ft	kg lb					*14 050 *30,300	9800 21,150	*10 050 *21,700	6300 13,600	7400 15,850	4450 9,500	5450 11,650	3250 6,900	*3050 *6,700	2500 5,500	10.33 33.91
Ground Line	kg lb			*5200 *11,950	*5200 *11,950	*15 550 *33,600	9300 20,000	10 300 22,150	6000 12,900	7200 15,450	4250 9,100	5350 11,500	3150 6,700	*3400 *7,450	2650 5,750	10.01 32.85
-1.5 m -5.0 ft	kg lb	*5550 *12,450	*5550 *12,450	*9050 *20,550	*9050 *20,550	*15 850 *34,300	9150 19,650	10 150 21,750	5850 12,600	7100 15,200	4150 8,900			*3950 *8,700	2950 6,450	9.40 30.81
-3.0 m -10.0 ft	kg lb	*9750 *21,900	*9750 *21,900	*14 150 *32,150	*14 150 *32,150	*15 150 *32,700	9200 19,750	10 150 21,750	5850 12,550	7100 15,250	4150 8,950			*4900 *10,900	3550 7,900	8.43 27.55
-4.5 m -15.0 ft	kg lb			*18 650 *40,150	*18 650 *40,150	*13 250 *28,400	9400 20,250	*9700 *20,700	6000 12,900					*5150 *11,000	5050 *11,000	6.94 22.46

\* Limited by hydraulic capacity rather than tipping load. The above loads are in compliance with SAE hydraulic excavator lift capacity rating standard J1097. They do not exceed 87% of hydraulic lifting capacity or 75% of tipping capacity. Weight of all lifting accessories must be deducted from the above lifting capacities.

# Reach Boom Lift Capacities



Load Point Height



Load Radius Over Front



Load Radius Over Side













Load at Maximum Reach

**R2.65CB2 STICK** – 2650 mm (8'9")  
**BUCKET** – 1.3 m<sup>3</sup> (1.70 yd<sup>3</sup>)

**UNDERCARRIAGE** – Standard  
**SHOES** – 600 mm (24") triple grouser

**BOOM** – 6150 mm (20'3")













		3.0 m (10.0 ft)		4.5 m (15.0 ft)		6.0 m (20.0 ft)		7.5 m (25.0 ft)		9.0 m (30.0 ft)				m ft
														
7.5 m 25.0 ft	kg lb											*3500 *7,750	3450 *7,750	8.34 27.06
6.0 m 20.0 ft	kg lb							6100 12,950	4100 8,700			*3400 *7,450	2750 6,150	9.21 30.07
4.5 m 15.0 ft	kg lb					*7850 *17,000	6000 12,850	6000 12,800	4000 8,550			*3400 *7,450	2400 5,250	9.72 31.82
3.0 m 10.0 ft	kg lb			*12 500 *26,850	8800 18,950	8450 18,150	5600 12,000	5800 12,400	3850 8,200			3500 7,700	2200 4,850	9.93 32.56
1.5 m 5.0 ft	kg lb			12 850 27,550	8050 17,300	8050 17,250	5250 11,200	5600 12,000	3650 7,800	4100 2600		3500 7,650	2200 4,800	9.86 32.37
Ground Line	kg lb			12 450 26,650	7700 16,500	7750 16,650	5000 10,700	5450 11,650	3500 7,500			3700 8,050	2300 5,050	9.52 31.24
-1.5 m -5.0 ft	kg lb	*8950 *20,350	*8950 *20,350	12 350 26,450	7600 16,350	7650 16,400	4900 10,450	5400 11,550	3450 7,400			4150 9,150	2650 5,800	8.87 29.07
-3.0 m -10.0 ft	kg lb	*15 700 *35,800	15 700 33,600	12 500 26,750	7750 16,600	7700 16,550	4900 10,550	5450 10,550	3500 7,400			5200 11,500	3350 7,450	7.83 25.54
-4.5 m -15.0 ft	kg lb	*16 500 *35,450	16 300 34,900	*12 050 *25,800	8050 17,300	7950 17,150	5150 11,150					7350 16,550	4800 10,750	6.32 20.50

\* Limited by hydraulic capacity rather than tipping load. The above loads are in compliance with SAE hydraulic excavator lift capacity rating standard J1097. They do not exceed 87% of hydraulic lifting capacity or 75% of tipping capacity. Weight of all lifting accessories must be deducted from the above lifting capacities.

**R3.2CB2 STICK** – 3200 mm (10'6")  
**BUCKET** – 1.1 m<sup>3</sup> (1.44 yd<sup>3</sup>)

**UNDERCARRIAGE** – Standard  
**SHOES** – 600 mm (24") triple grouser

**BOOM** – 6150 mm (20'3")

		1.5 m (5.0 ft)		3.0 m (10.0 ft)		4.5 m (15.0 ft)		6.0 m (20.0 ft)		7.5 m (25.0 ft)		9.0 m (30.0 ft)				m ft
																
7.5 m 25.0 ft	kg lb									*4550 *13,150	4300 9,100			*2850 *6,250	*2850 *6,250	8.91 28.95
6.0 m 20.0 ft	kg lb									*6050 *13,150	4300 9,100			*2750 *6,000	2600 5,750	9.72 31.75
4.5 m 15.0 ft	kg lb							*7250 *15,650	6200 13,250	6150 13,150	4150 8,850	4350 *8,000	2850 6,050	*2750 *6,050	2250 5,000	10.19 33.39
3.0 m 10.0 ft	kg lb					*11 450 *24,550	9150 19,650	8650 18,550	5750 12,400	3950 12,700	3950 8,450	4300 9,150	2800 5,900	*2850 *6,300	2100 4,600	10.39 34.09
1.5 m 5.0 ft	kg lb					13 100 28,150	8300 17,800	8200 17,550	5350 11,500	5700 12,200	3750 8,000	4150 8,900	2700 5,700	*3100 *6,750	2050 4,550	10.33 33.91
Ground Line	kg lb			*5250 *12,000	*5250 *12,000	12 550 26,900	7800 16,750	7850 16,850	5050 10,850	5500 11,800	3550 7,600	4100 8,750	2600 5,550	*3450 *7,550	2150 4,750	10.01 32.85
-1.5 m -5.0 ft	kg lb	*5600 *12,500	*5600 *12,500	*9100 *20,600	*9100 *20,600	12 350 26,500	7650 16,350	7650 16,450	4900 10,500	5400 11,600	3450 7,400			3800 8,400	2400 5,300	9.40 30.81
-3.0 m -10.0 ft	kg lb	*9800 *21,950	*9800 *21,950	*14 200 *32,200	*14 200 *32,200	12 400 26,600	7650 16,450	7650 16,450	4900 10,500	5400 11,650	3500 7,450			4600 10,200	3000 6,600	8.43 27.55
-4.5 m -15.0 ft	kg lb			*18 700 *40,200	16 000 34,200	12 650 27,150	7900 16,950	7850 16,850	5050 10,850					*5150 *11,050	4250 9,600	6.94 22.46

\* Limited by hydraulic capacity rather than tipping load. The above loads are in compliance with SAE hydraulic excavator lift capacity rating standard J1097. They do not exceed 87% of hydraulic lifting capacity or 75% of tipping capacity. Weight of all lifting accessories must be deducted from the above lifting capacities.

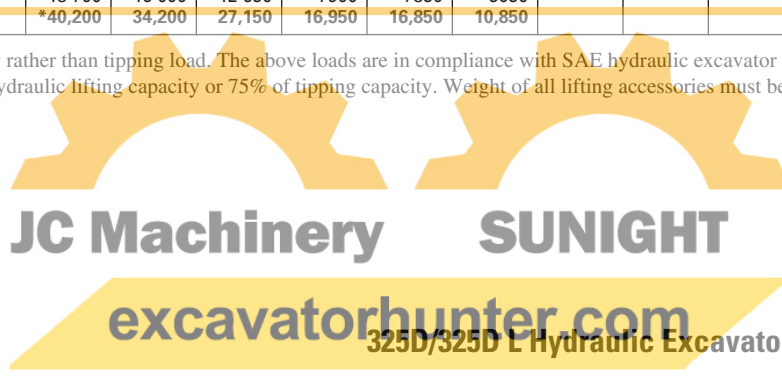

# Mass Boom Lift Capacities



Load Point Height



Load Radius Over Front



Load Radius Over Side



Load at Maximum Reach

**M2.5DB STICK** – 2500 mm (8'3")  
**BUCKET** – 1.6 m<sup>3</sup> (2.09 yd<sup>3</sup>)

**UNDERCARRIAGE** – Long  
**SHOES** – 600 mm (24") triple grouser

**BOOM** – 5550 mm (18'3")

Diagram	1.5 m (5.0 ft)		3.0 m (10.0 ft)		4.5 m (15.0 ft)		6.0 m (20.0 ft)		7.5 m (25.0 ft)		Diagram		m ft	
	Front	Side	Front	Side	Front	Side	Front	Side	Front	Side	Front	Side		
7.5 m 25.0 ft	kg lb											*3900 *8,650	*3900 *8,650	7.38 23.85
6.0 m 20.0 ft	kg lb						*7200 *15,800	6800 14,550				*3750 *8,300	3650 8,150	8.38 27.34
4.5 m 15.0 ft	kg lb						*8000 *17,400	6600 14,150	*7100 *14,000	4300 9,150		*3800 *8,350	3100 6,850	8.95 29.30
3.0 m 10.0 ft	kg lb					*12 150 *26,100	10 150 21,800	*9250 *20,000	6250 13,400	7050 15,100	4150 8,900	*4000 *8,800	2850 6,250	9.18 30.10
1.5 m 5.0 ft	kg lb					*14 500 *31,250	9300 20,000	10 100 21,700	5900 12,600	6900 14,750	4000 8,550	*4400 *9,600	2800 6,150	9.10 29.87
Ground Line	kg lb			*8100 *18,600	*8100 *18,600	*15 600 *33,750	8850 19,050	9800 21,050	5600 12,050	6750 14,450	3900 8,300	*5000 *11,000	3000 6,600	8.71 28.59
-1.5 m -5.0 ft	kg lb	*8650 *19,300	*8650 *19,300	*14 400 *32,750	*14 400 *32,750	*15 400 *33,350	8750 18,800	9700 20,800	5500 11,850			*6050 *13,350	3550 7,800	7.97 26.11
-3.0 m -10.0 ft	kg lb			*19 700 *42,600	18 550 39,650	*13 850 *29,900	8900 19,100	9800 21,050	5600 12,050			*5900 *12,950	4850 10,800	6.75 21.98
-4.5 m -15.0 ft	kg lb					*10 000 *20,850	9350 20,150					*8450 *18,550	7850 17,850	5.03 16.19

\* Limited by hydraulic capacity rather than tipping load. The above loads are in compliance with SAE hydraulic excavator lift capacity rating standard J1097. They do not exceed 87% of hydraulic lifting capacity or 75% of tipping capacity. Weight of all lifting accessories must be deducted from the above lifting capacities.

**M3.2DB STICK** – 3200 mm (10'6")  
**BUCKET** – 1.5 m<sup>3</sup> (1.96 yd<sup>3</sup>)

**UNDERCARRIAGE** – Long  
**SHOES** – 600 mm (24") triple grouser

**BOOM** – 5550 mm (18'3")

Diagram	1.5 m (5.0 ft)		3.0 m (10.0 ft)		4.5 m (15.0 ft)		6.0 m (20.0 ft)		7.5 m (25.0 ft)		Diagram		m ft	
	Front	Side	Front	Side	Front	Side	Front	Side	Front	Side	Front	Side		
7.5 m 25.0 ft	kg lb											*2650 *5,850	*2650 *5,850	8.14 26.40
6.0 m 20.0 ft	kg lb								*4800 *9,550	4700 *9,550		*2500 *5,550	*2500 *5,550	9.04 29.50
4.5 m 15.0 ft	kg lb						*7300 *15,900	6950 14,950	*6400 *13,450	4600 9,850		*2550 *5,550	*2550 *5,550	9.55 31.29
3.0 m 10.0 ft	kg lb			*16 750 *35,700	*16 750 *35,700	*10 950 *23,600	10 700 23,000	*8650 *18,750	6600 14,150	7350 15,750	4450 9,500	*2650 *5,800	*2650 *5,800	9.77 32.04
1.5 m 5.0 ft	kg lb			*8800 *20,950	*8800 *20,950	*13 750 *29,650	9800 21,100	*10 050 *21,750	6200 13,300	7150 15,250	4250 9,100	*2900 *6,300	2650 5,800	9.70 31.84
Ground Line	kg lb			*9000 *20,550	*9000 *20,550	*15 500 *33,450	9250 19,800	10 100 21,600	5850 12,600	6950 14,900	4100 8,750	*3300 *7,200	2800 6,100	9.36 30.69
-1.5 m -5.0 ft	kg lb	*7350 *16,400	*7350 *16,400	*12 800 *29,050	*12 800 *29,050	*15 900 *34,400	9000 19,250	9900 21,200	5700 12,250	6850 14,700	4000 8,550	*3950 *8,650	3150 6,950	8.69 28.47
-3.0 m -10.0 ft	kg lb	*12 000 *26,950	*12 000 *26,950	*18 900 *43,000	18 600 39,700	*15 050 *32,450	9000 19,300	9900 21,200	5700 12,250			*5150 *11,450	4000 8,950	7.62 24.85
-4.5 m -15.0 ft	kg lb			*17 800 *38,150	*17 800 *38,150	*12 400 *26,450	9250 19,900	*8450	5900			*8200 *18,050	5800 13,000	6.09 19.72

\* Limited by hydraulic capacity rather than tipping load. The above loads are in compliance with SAE hydraulic excavator lift capacity rating standard J1097. They do not exceed 87% of hydraulic lifting capacity or 75% of tipping capacity. Weight of all lifting accessories must be deducted from the above lifting capacities.

## Standard Equipment

*Standard equipment may vary. Consult your Caterpillar dealer for details.*

### Upper Structure

#### Electrical

- Alternator, 80A
- Light, storage box mounted (one)
- Signaling/Warning horn

#### Engine

- Cat C7 with ACERT Technology
- 2300 m (7,500 ft) altitude capability with no deration
- Air intake heater
- Automatic engine speed control
- EU Stage II compliant
- Radial seal air filter
- Water separator in fuel line
- Waved fin radiator with space for cleaning
- 2 micron fuel filter
- Automatic swing parking brake
- Boom drift reducing valve
- Boom lowering device for back-up
- Caterpillar one key security system
- Counterweight
- Door locks and cap locks
- Mirrors, rearview (frame-right, cab-left)
- Regeneration circuit for boom and stick
- Reverse swing damping valve
- Stick drift reducing valve
- Two speed travel

### Operator Station

#### Cab

- Adjustable armrest
- Ashtray with lighter
- Beverage holder
- Bi-Level air conditioner (automatic) with defroster
- Bolt-on FOGS capability
- Capability of installing two additional pedals
- Coat hook
- Front windshield glass split 70/30
- Interior lighting
- Literature holder
- Mounting for two stereo speakers (two locations)
- Neutral lever (lock out) for all controls
- Openable front windshield with assist device
- Openable skylight
- Pillar mounted upper windshield wiper and washer
- Pressurized cab (positive filtered ventilation)
- Radio mounting (DIN size)
- Rear window, emergency exit
- Removable lower windshield with in-cab storage bracket
- Seat with integrated, adjustable console
- Seat belt, retractable (two inch width)
- Sliding upper door window
- Storage compartment suitable for lunch box
- Travel control pedals with removable hand levers
- Utility space for magazine
- Washable floor mat

#### Monitor

- Economy mode
- Full time clock
- Language display – Full color and graphical display
- Machine condition, error code and tool mode setting
- Start-up level check for hydraulic oil, engine oil and coolant
- Warning information, filter/fluid change information and working hour

#### Undercarriage

- Grease lubricated GLT2, resin seal
- Idler and center section track guiding
- 800 mm (36 in) triple grouser track shoe (325D L)
- 600 mm (24 in) triple grouser track shoes (325D)

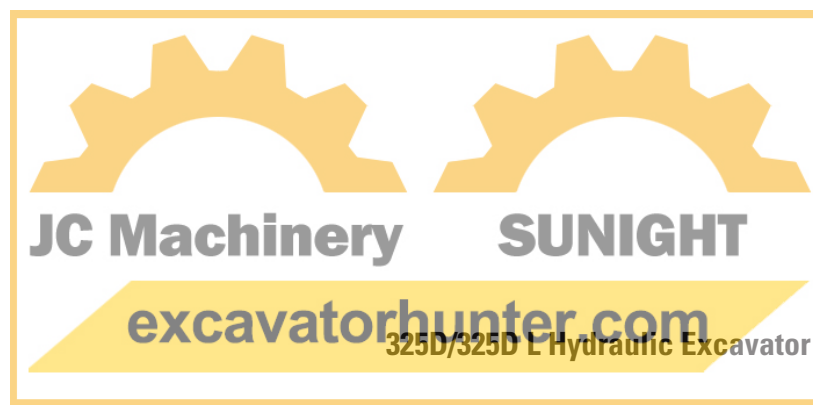

## Optional Equipment

*Optional equipment may vary. Consult your Caterpillar dealer for details.*

### Front Linkage

- Bucket linkage, CB2-family with lifting eye
- Bucket linkage, DB-family with lifting eye
- Heavy-duty 6.15 m (20 ft 2 in) reach boom (with left and right side light)
- Heavy-duty 2.65 m (8 ft 8 in) stick for heavy-duty reach boom
- Reach boom 6.15 m (20 ft 2 in) with left and right side light
  - R3.2CB 3200 mm (10 ft 6 in) stick
  - R3.0CB 3000 mm (9 ft 10 in) stick
  - R2.65CB 2650 mm (8 ft 8 in) stick
- Mass boom 5.55 m (18 ft 3 in) with left and right side light
  - M3.2CB 3200 mm (10 ft 6 in) stick
  - M2.5DB 2500 mm (8 ft 2 in) stick

### Track

- Standard undercarriage
  - 700 mm (28 in) triple grouser shoes
  - 800 mm (32 in) triple grouser shoes
- Long Undercarriage
  - 600 mm (24 in) triple grouser shoes
  - 700 mm (28 in) triple grouser shoes

### Guards

- FOGS, bolt-on
- Guard, cab front
- Guard, cab top
- Guard, full length for long and long narrow undercarriage (two piece)
- Guard, heavy-duty bottom, 4 mm ( $\frac{5}{32}$  in), with out swivel guard and travel motor protection
- Guard, track end guide for long, long narrow undercarriage
- Guard, track end guide for standard undercarriage
- Guard, vandalism
- Heavy-duty swivel protection, 16 mm ( $\frac{5}{8}$  in), swivel guard only
- Heavy-duty travel motor protection
- Net for front guard (full net, one piece)
- Net for front guard (half net, one piece)
- Swivel protection, 6 mm ( $\frac{1}{4}$  in), swivel guard only

### Auxiliary Hydraulics and Lines

- Additional circuit
  - Hammer return filter circuit
- Boom and stick lines
  - Cat quick coupler line (high and medium pressure capable)
  - Drain line
  - High pressure line
  - Medium pressure line
- Quick coupler
  - Quick coupler for high pressure
- Tool control system
  - Configuration 1 (hammer 1), foot pedal operated 1P, one-way circuit
  - Configuration 2 (common), foot pedals operated 1/2P, common circuit
  - Configuration 3 (hammer 2), foot pedal operated 2P, one-way circuit

### Operator Station

- Tempered glass windows
- Polycarbonate windows
- Power supply, 12V-7A (1)
- Power supply, 12V-7A (2)
- Rear window emergency exit
- Seat, high-back air suspension
- Seat, high-back air suspension with heater
- Seat, high-back mechanical suspension
- Seat, low-back suspension without headrest
- Headrest
- Sunscreen
- Windshield wiper, lower with washer
- Working lights, cab mounted
- Rain protector for front windshield
- Sun visor
- AM/FM radio
- Control pattern quick-changer, two way
- Control pattern quick-changer, four way
- Cat MSS (anti-theft device)
- Lunch box with cover
- Water level indicator for water separator

### Other Optional Equipment

- Additional gear train for auxiliary pump
- Air pre-filter
- Cooling package, high ambient with VSF
- Cooling package, semi-high ambient
- Electric refueling pump with auto shut off
- Fine swing
- Starting kit, cold weather,  $-32^{\circ}$  C ( $-26^{\circ}$  F)
- Travel alarm





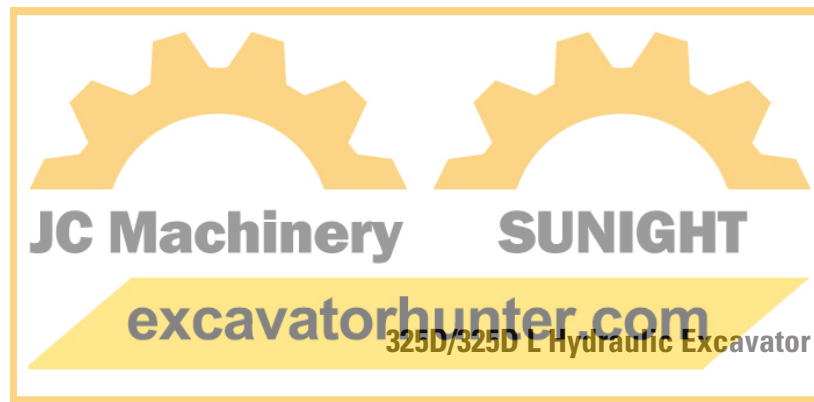



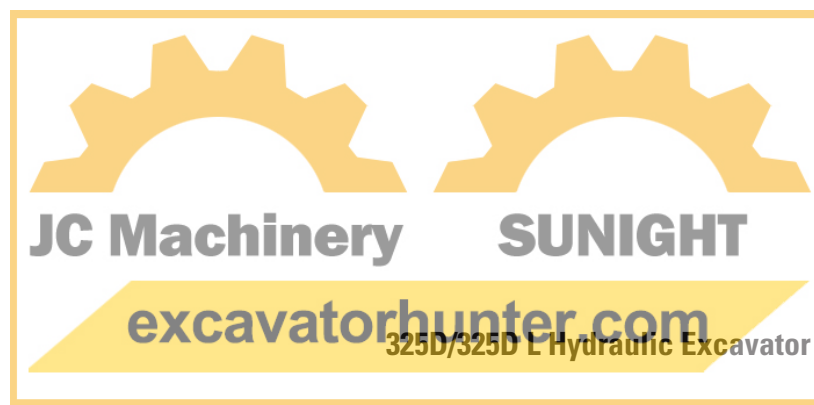

# 325D/325D L Hydraulic Excavator

AEHQ5666-03 (5-07)

Replaces AEHQ5666-02

APD

For more complete information on Cat products, dealer services,  
and industry solutions, visit us on the web at [www.cat.com](http://www.cat.com)

© 2007 Caterpillar  
All Rights Reserved  
Printed in U.S.A.

Materials and specifications are subject to change without notice.  
Featured machines in photos may include additional equipment.  
See your Caterpillar dealer for available options.

CAT, CATERPILLAR, their respective logos, ACERT, "Caterpillar Yellow" and the  
POWER EDGE trade dress, as well as corporate and product identity used herein,  
are trademarks of Caterpillar and may not be used without permission.

