

# 330C

## Hydraulic Excavator



### Engine

Engine Model	Cat® C9	
Flywheel Power	184 kW	247 hp

### Weights

Operating Weight - Long Undercarriage	34 800 kg	76,700 lb
Operating Weight Std. Undercarriage	33 400 kg	73,600 lb



**JC Machinery**

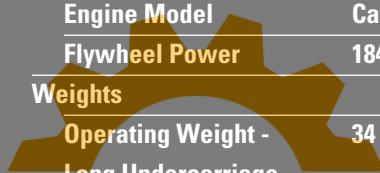

**SUNIGHT**

[excavatorhunter.com](http://excavatorhunter.com)

# 330C Hydraulic Excavator

---

## Engine and Hydraulics

- ✓ New to the 330C, the Cat C9 engine combines with proven hydraulics to give the 330C consistently high power and control in the field. **pg. 4**

---

## Structures

Rugged Caterpillar® undercarriage design and proven structural manufacturing techniques assure outstanding durability in the toughest applications. **pg. 5**

---

## Booms and Sticks

Built for good performance and long service life, Caterpillar booms and sticks are large, welded, box-section structures with thick, multi-plate fabrications to resist high stress. Caterpillar offers various front combinations to meet various demands. **pg. 6**

---

## Complete Customer Support

Your Cat dealer offers a wide range of services that can be set up under a customer support agreement when you purchase your equipment. The dealer will help you choose a plan that can cover everything from machine and attachment selection to replacement. **pg. 11**

*Increased work tool options, improved cycle times, and ease of operation lead to increased productivity and lower operating costs.*



**JC Machinery**      **SUNIGHT**  
**excavatorhunter.com**



---

### Operator Station

- ✓ The 330C operator work station is quiet with ergonomic control placement and convenient adjustments, low lever and pedal effort, ergonomic seat design and highly efficient ventilation. **pg. 7**

---

### Work Tools - Attachments

- ✓ The Tool Control System of the 330C allows the hydraulic system to handle most hydromechanical tools. Tool setting can be programmed and selected from the monitor. **pg. 8**

---

### Serviceability

Longer service intervals and easier maintenance results in better machine availability and lower owning and operating costs. **pg. 10**



**JC Machinery**      **SUNIGHT**  
excavatorhunter.com

✓ *New Feature*

## Engine and Hydraulics

*Cat C9 engine and hydraulics give the 330C exceptional power, efficiency and controllability unmatched in the industry for consistently high performance in all applications.*



**Engine.** Six cylinder turbocharged engine built for power, reliability, economy and low emissions will keep the machine up and running.

**Automatic Engine Speed Control.**

The three-stage, one-touch control maximizes fuel efficiency and reduces sound levels.

**Low Sound, Low Vibration.** The C9 design improves operator comfort by reducing sound and vibration.

**Electronic Control Module.** The Electronic Control Module (ECM) works as the “brain” of the engine’s control system, responding quickly to operating variables to maximize engine efficiency. Fully integrated with sensors in the engine’s fuel, air, coolant, and exhaust systems, the ECM stores and relays information on conditions such as rpm, fuel consumption, and diagnostic information.

**Hydraulic Cross Sensing System.**

Improves productivity with faster implement speeds and quicker, stronger pivot turns.

**Optional Fine Swing Control.** Optional fine swing control cushions swing start and stop for better implement control.

**Hydraulic Cylinder Snubbers.** The hydraulic cylinder snubbers at rod-end of boom cylinders and both ends of stick cylinders cushion shocks, reduce sound and increase cylinder life, keeping the machine working longer.

**Controllability.** The hydraulic system offers precise control to the 330C, reducing operator fatigue, improving operator effectiveness and efficiency, which ultimately translates into enhanced performance.

**Boom and Stick Regeneration Circuit.**

Boom and stick regeneration circuit increases efficiency and reduces cycle times for higher productivity and lower operating costs.



## Structures

*330C structural components and undercarriage are the backbone of the machine's durability.*

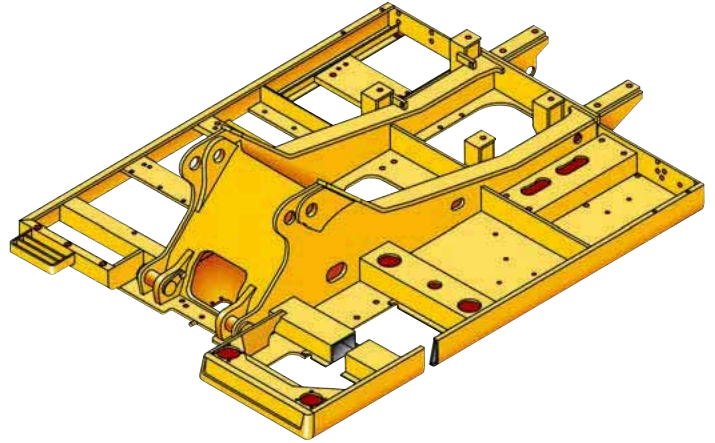
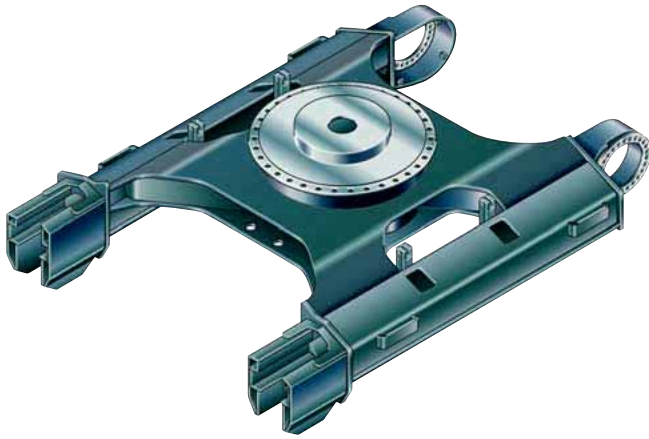

**Robotic Welding.** Up to 95% of the structural welds on a Caterpillar Excavator are completed by robots. Robotic welds achieve up to three times the penetration of manual welds.

**Carbody Design and Track Roller Frames.** X-shaped, box-section carbody provides excellent resistance to torsional bending. Robot-welded track roller frames are press-formed, pentagonal units to deliver exceptional strength and service life.

**Main Frame.** Rugged main frame is designed for maximum durability and efficient use of materials.

**Undercarriage.** Durable Cat undercarriage absorbs stresses and provides excellent stability.

**Rollers and Idlers.** Sealed and lubricated track rollers, carrier rollers and idlers provide excellent service life, to keep the machine in the field longer.

**Grease Lubricated Track.** The Grease Lubricated Track provides long track pin and bushing wear, and quiet travel.

**Standard Undercarriage.** The standard undercarriage is well suited for applications that require frequent repositioning of the machine, have restricted working space, uneven or rocky terrain.

**Long Undercarriage.** The long (L) undercarriage maximizes stability and lift capacity. This long, wide and sturdy undercarriage offers a very stable work platform.





## Booms and Sticks

*Built for performance and long service life, Caterpillar booms and sticks are large, welded, box-section structures with thick, multi-plate fabrications in high-stress areas.*

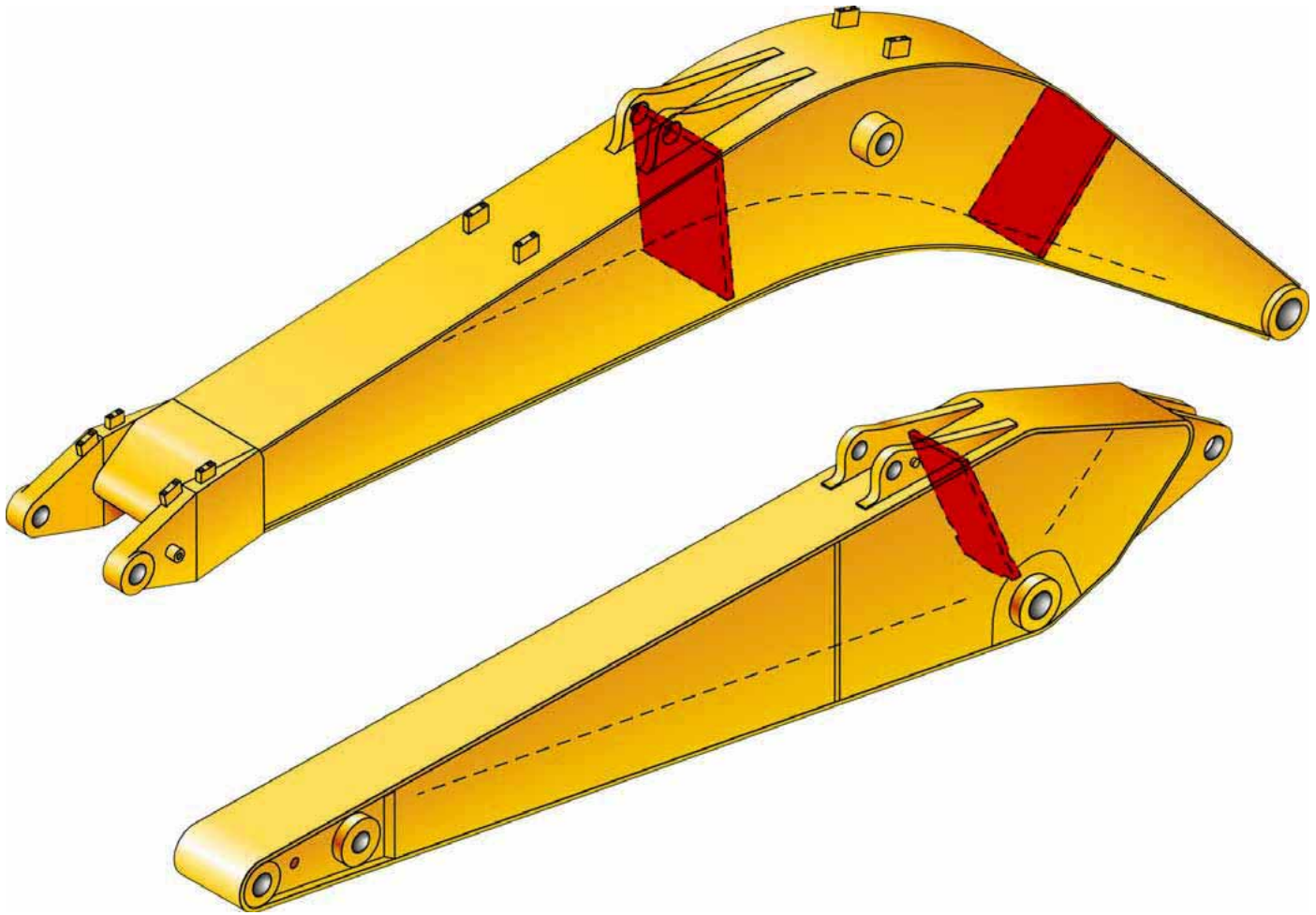

**Reach Boom.** The reach boom features an optimum design that maximizes digging envelopes with two stick choices.

**R3.9D Stick.** Made of high-tensile strength steel and designed with the same application needs in mind as the R3.2D, with the added capability of increased reach and depth.

**R3.2D Stick.** The R3.2D Stick provides the capacity for excellent reach and depth in trenching and general construction applications.

**Mass Excavation Boom.** The mass excavation boom maximizes productivity. The mass version offers significantly higher digging forces and allows use of larger buckets.

**M2.6E Stick.** The M2.6E stick is used with the mass excavation boom is designed for truck loading in larger earth moving applications.



## Operator Station

*Redesigned interior layout maximizes operator space and provides exceptional comfort.*

**Operator Station.** The 330C operator work station is quiet with ergonomic control placement and convenient adjustments, low lever and pedal effort, ergonomic seat design and highly efficient ventilation.

**Redesigned Layout.** Redesigned cab layout emphasizes simplicity and ease of use. Right-hand wall and console provide easy access to all switches, dials and controls.

**Console.** Redesigned consoles feature simplicity and functionality. Both consoles have attached adjustable armrests.

**Automatic Climate Control.** Fully automatic climate control adjusts temperature and flow and determines which air outlet is best in each situation.

**Upper Cab Door Window.** The upper cab door window slides open, providing extra ventilation and allowing communication with people outside.

**Skylight.** A large polycarbonate skylight delivers excellent natural lighting and good ventilation. Standard sliding sunshade protects the operator from direct sunlight.

**Cab Attachments.** A variety of cab attachments for additional functionality, comfort and security are available.



**Windshield.** The upper front windshield opens, closes and stores below the roof above the operator. Grips on the mid-lower part of the front windshield make opening easy.

**Monitor.** New, compact monitor enhances viewing while displaying a variety of easy to read and understand language-based information.





## Work Tools - Attachments

*Increased offerings of work tools help optimize machine performance.*

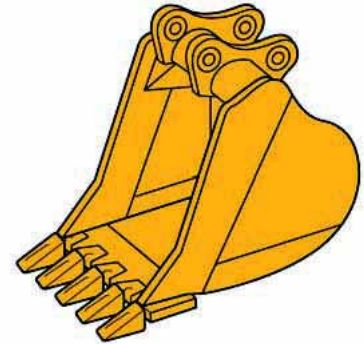

*Excavation Bucket (EX)*

**Excavation Bucket (EX).** Having a large bucket capacity and tip radius, the Excavation Bucket is designed for general-purpose excavation, ranging from low or medium-friction soft earth to hard earth.

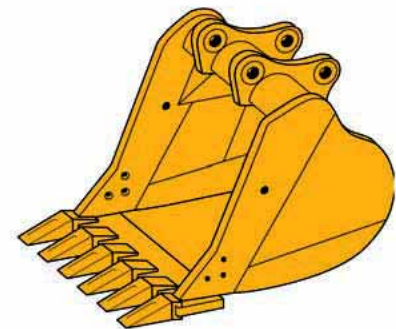

*Mass Excavation Bucket (MX)*

**Mass Excavation Bucket (MX).** The Mass Excavation Bucket has a high load factor, ensuring high productivity and is designed for mass earthmoving and loading.

**Buckets.** Caterpillar buckets provide increased service life with reduced repair costs. All buckets feature dual radius design for increased heel clearance and reduced wear, robot welding of hinge assembly and other critical areas for increased weld penetration and longer life, and high strength.





**Monitor.** With optional tool control system, up to five different tool settings may be pre-programmed and selected from the electronic controller through the monitor.

**Work Tools.** Choose from a variety of work tools such as hammers, shears, thumbs, rotators, grapples or crushers. Ask your Cat dealer for information on attachments or special configurations.



*Multi-processor*



*Hammer*



**Tool Control System.** The optional tool control system maximizes work tool productivity by configuring hydraulic flow, pressure, and operator controls to match a specific work tool. System versatility enables a wide range of tools to be used. Factory installed combined function, hammer and thumb circuits are available as attachments.



*Thumb*



**JC Machinery**      **SUNIGHT**

**excavatorhunter.com**

## Serviceability

*Simplified service and maintenance features save you time and money.*

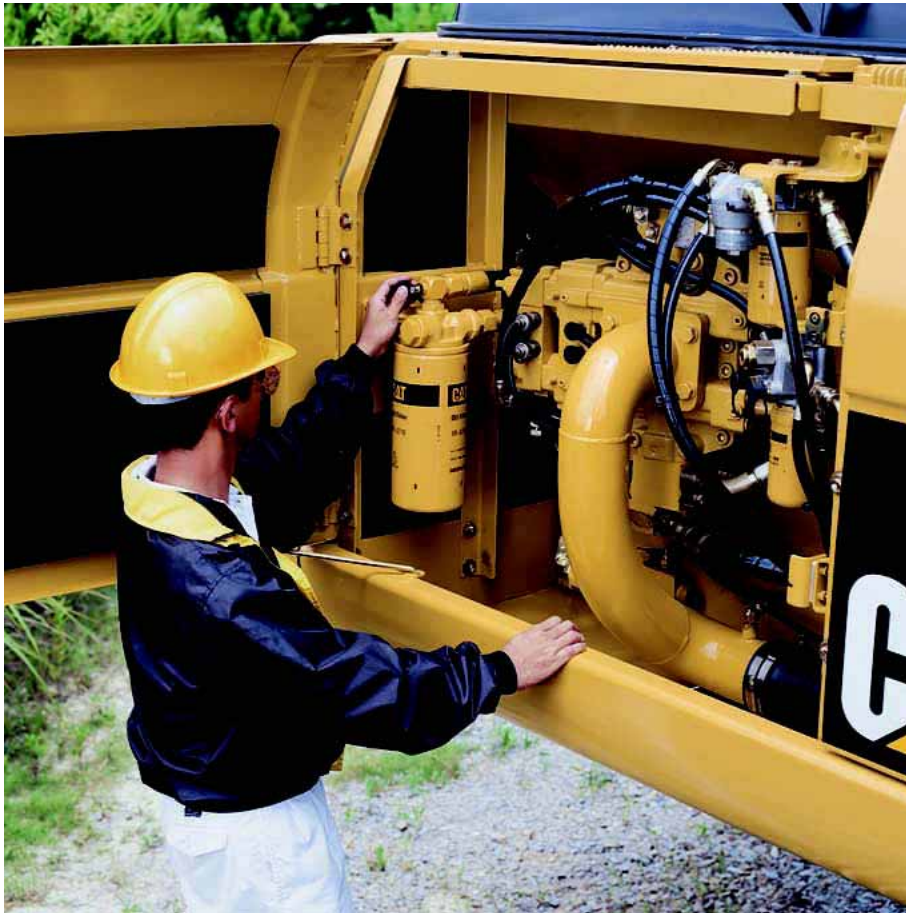

**Extended Service Interval.** 330C service and maintenance intervals have been extended to reduce machine service time and increase machine availability.

**Radiator Compartment.** The left rear service door allows easy access to the engine radiator. A reserve tank and drain cock are attached to the radiator for simplified maintenance.

**Air Filter Compartment.** The air filter features a double-element construction for superior cleaning efficiency. When the air cleaner plugs, a warning is displayed on the monitor screen inside the cab.

**Ground Level Service.** The design and layout of the 330C was made with the service technician in mind. Many service locations are easily accessible at ground level allowing critical maintenance to get done quickly and efficiently.

**Pump Compartment.** A service door on the right side of the upper structure allows ground-level access to the pump and pilot filter.

**Capsule Filter.** The hydraulic return filter, a capsule filter, is situated outside the hydraulic tank. This filter prevents contaminants from entering the system when hydraulic oil is changed and keeps the operation clean.

**Diagnostics and Monitoring.** The 330C is equipped with S•O•S<sup>SM</sup> sampling ports and hydraulic test ports for the hydraulic system, engine oil and for coolant. A test connection for the Electronic Technician (ET) service tool is located behind the cab.

**Anti-Skid "Punched Star" Plate.** Anti-skid punched-star plate covers top of storage box and upper structure to prevent slipping during maintenance. The plate can be removed for cleaning.

**Fan Guard.** Engine radiator fan is completely enclosed by fine wire mesh, reducing the risk of an accident.

**Greasing Points.** A concentrated remote greasing block on the boom delivers grease to hard-to-reach locations.





## Complete Customer Support

*Cat dealer services help you operate longer with lower costs.*

**Selection.** Make detailed comparisons of the machines you are considering before you buy. What are the job requirements? What production is needed? What is the true cost of lost production? Your Cat dealer can give you precise answers to these questions.

**Operation.** Improving operating techniques can boost your profits. Your Cat dealer has training literature and other ideas to help you increase productivity.

**Maintenance.** Repair option programs guarantee the cost of repairs up front. Diagnostic programs such as Scheduled Oil Sampling and Technical Analysis help you avoid unscheduled repairs.

**Replacement.** Repair, rebuild or replace? Your Cat dealer can help you evaluate the cost involved so you can make the right choice.

**Product Support.** You will find nearly all parts at our dealer parts counter. Cat dealers utilize a worldwide computer network to find in-stock parts to minimize machine down time. Save money with remanufactured components.

**Acquisition.** Look past initial price, look at the value the 330C offers. Consider the financing options available as well as day-to-day operating costs.





## Engine

Engine Model	CAT C9	
Flywheel Power	184 kW	247 hp
ISO 9249	184 kW	247 hp
SAE J1349	182 kW	244 hp
EEC 80/1269	184 kW	247 hp
Bore	112 mm	4.41 in
Stroke	149 mm	5.87 in
Displacement	8.8 L	537 in <sup>3</sup>

## Weights

Operating Weight - Long Undercarriage	34 800 kg	76,700 lb
---------------------------------------	-----------	-----------

- 6.5 m (21'4") boom, 3.9 m (12'10") stick, D1.3X bucket, and 750 mm (30") track shoes.

Operating Weight - Std. Undercarriage	33 400 kg	73,600 lb
---------------------------------------	-----------	-----------

- 6.5 m (21'4") boom, 3.9 m (12'10") stick, D1.3X bucket, and 600 mm (24") track shoes.

## Service Refill Capacities

Fuel Tank Capacity	618 L	163 gal
Cooling System	38 L	10 gal
Engine Oil	36 L	9.4 gal
Swing Drive	19 L	5 gal
Final Drive (each)	15 L	4 gal
Hydraulic System (including tank)	410 L	108 gal
Hydraulic Tank	175 L	46 gal

## Sound Performance

Performance	ANSI/SAE
-------------	----------

- The operator sound exposure Leq (equivalent sound pressure level) measured according to the work cycle procedures specified in ANSI/SAE J1166 OCT98 is 74 dB(A), for the cab offered by Caterpillar, when properly installed and maintained and tested with the doors and windows closed.
- Hearing protection may be needed when operating with an open operator station and cab (when not properly maintained or doors/windows open) for extended periods or in noisy environment.

## Standards

Brakes	SAE J1026 APR90	
Cab/FOGS	SAE J1356 FEB88 ISO 10262	

## Hydraulic System

Main Implement System - Maximum Flow (2x)	280 L/min	74 gal/min
Max. pressure - Implements (Full Time)	34 300 kPa	4,974 psi
Max. pressure - Travel	34 300 kPa	4,974 psi
Max. pressure - Swing	27 900 kPa	4,046 psi
Pilot System - Maximum flow	37 L/min	10 gal/min
Pilot System - Maximum pressure	4120 kPa	597 psi
Boom Cylinder - Bore	150 mm	5.91 in
Boom Cylinder - Stroke	1440 mm	57 in
Stick Cylinder - Bore	170 mm	6.69 in
Stick Cylinder - Stroke	1738 mm	68 in
D Family Bucket Cylinder - Bore	150 mm	5.91 in
D Family Bucket Cylinder - Stroke	1156 mm	46 in
E Family Bucket Cylinder - Bore	160 mm	6.3 in
E Family Bucket Cylinder - Stroke	1356 mm	53 in

## Drive

Maximum Drawbar Pull	294 kN	66,094 lb
Maximum Travel Speed	5 kph	3.1 mph

## Swing Mechanism

Swing Speed	10 RPM	
Swing Torque	108 kN·m	79,657 lb ft

## Track

Standard w/Standard Undercarriage	600 mm	24 in
Standard w/Long Undercarriage	750 mm	30 in
Optional	750 mm	30 in
Optional	850 mm	34 in

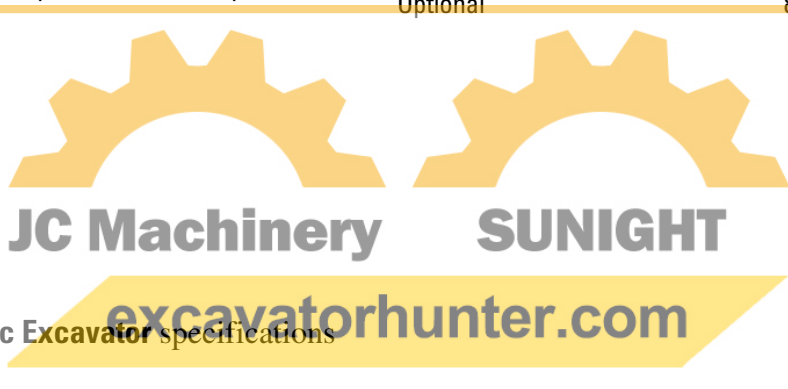

# Dimensions

All dimensions are approximate.

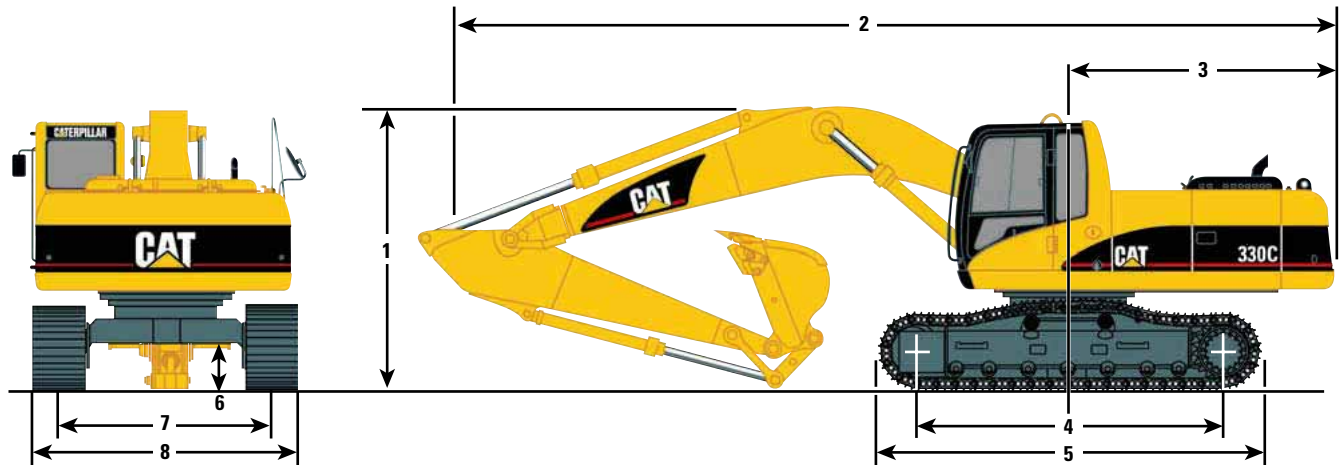

Boom Options	Reach — 6.5 m (21'4")	Reach — 6.5 m (21'4")	Reach — 6.5 m (21'4")	Mass — 6.18 m (20'3")
<b>Stick Options</b>	<b>R3.9D m (12'10")</b>	<b>R3.2D m (10'6")</b>	<b>R2.8D m (9'2")</b>	<b>M2.55E (8'4")</b>
<b>1</b> Shipping height	3730 mm (12'3")	3350 mm (11'0")	3590 mm (11'9")	3490 mm (11'5")
<b>2</b> Shipping length	11 190 mm (36'9")	11 140 mm (36'7")	11 200 mm (36'9")	10 840 mm (35'7")
<b>3</b> Tail swing radius	3500 mm (11'6")	3500 mm (11'6")	3500 mm (11'6")	3500 mm (11'6")
<b>4</b> Length to centers of rollers				
Standard undercarriage	3610 mm (11'10")	3610 mm (11'10")	3610 mm (11'10")	3610 mm (11'10")
Long undercarriage	4040 mm (13'3")	4040 mm (13'3")	4040 mm (13'3")	4040 mm (13'3")
<b>5</b> Track length				
Standard undercarriage	4580 mm (15'0")	4580 mm (15'0")	4580 mm (15'0")	4580 mm (15'0")
Long undercarriage	5020 mm (16'6")	5020 mm (16'6")	5020 mm (16'6")	5020 mm (16'6")
<b>6</b> Ground clearance	510 mm (1'8")	510 mm (1'8")	510 mm (1'8")	510 mm (1'8")
<b>7</b> Track gauge				
Standard undercarriage	2590 mm (8'6")	2590 mm (8'6")	2590 mm (8'6")	2590 mm (8'6")
Long undercarriage	2590 mm (8'6")	2590 mm (8'6")	2590 mm (8'6")	2590 mm (8'6")
<b>8</b> Shipping width with 600 mm (24") Shoes				
Standard undercarriage	3190 (10'6")	3190 (10'6")	3190 (10'6")	3190 (10'6")
Long undercarriage	3190 (10'6")	3190 (10'6")	3190 (10'6")	3190 (10'6")
Shipping width with 750 mm (30") Shoes				
Standard undercarriage	3340 (10'11")	3340 (10'11")	3340 (10'11")	3340 (10'11")
Long undercarriage	3340 (10'11")	3340 (10'11")	3340 (10'11")	3340 (10'11")
Shipping width with 850 mm (34") Shoes				
Standard undercarriage	3440 (11'3")	3440 (11'3")	3440 (11'3")	3440 (11'3")
Long undercarriage	3440 (11'3")	3440 (11'3")	3440 (11'3")	3440 (11'3")

Operating Weight	600 mm (24") Shoes — STD			750 mm (30") Shoes — LC		
	Bucket	kg	lb	Bucket	kg	lb
<b>Reach Boom 6.5 m (21'4")</b>						
Sticks: 3.9 m (12'10")	1.3 m <sup>3</sup> (1.7 yd <sup>3</sup> )	33 400	73,600	1.3 m <sup>3</sup> (1.7 yd <sup>3</sup> )	34 800	76,700
3.2 m (10'6")	1.4 m <sup>3</sup> (1.8 yd <sup>3</sup> )	33 300	73,400	1.5 m <sup>3</sup> (2.0 yd <sup>3</sup> )	34 700	76,500
2.8 m (9'2")	1.5 m <sup>3</sup> (2.0 yd <sup>3</sup> )	33 200	73,200	1.6 m <sup>3</sup> (2.1 yd <sup>3</sup> )	34 700	76,500
<b>Mass Boom 6.18 m (20'3")</b>						
Sticks: 2.55 m (8'4")	1.7 m <sup>3</sup> (2.2 yd <sup>3</sup> )	33 900	74,700	1.9 m <sup>3</sup> (2.5 yd <sup>3</sup> )	35 400	78,000

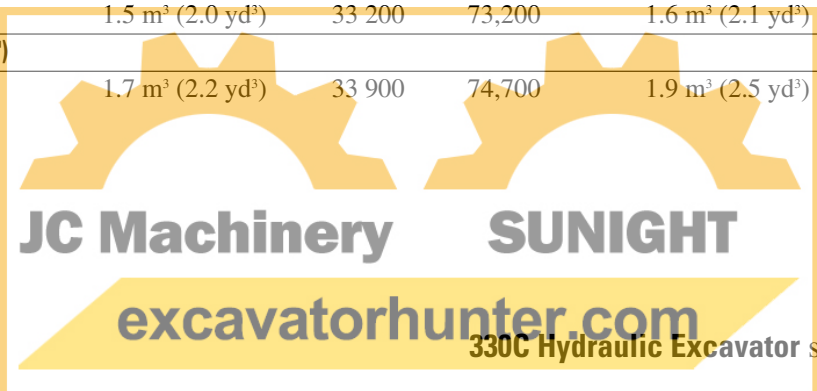

# Working Ranges

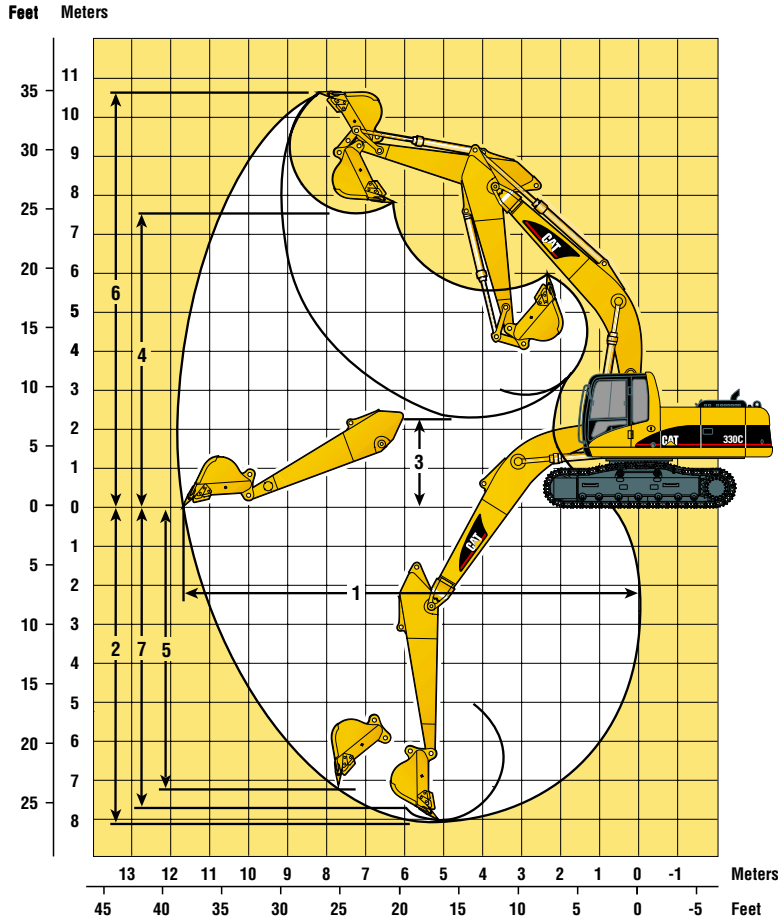

# Major Component Weights

Booms: including lines, boom cylinders, stick cylinders and left side light

	kg	lb
Reach	3880	8600
Mass	3950	8700

Sticks: including bucket cylinder and bucket linkage

	kg	lb
R3.9 m	1340	3000
R3.2 m	1210	2700
R2.8 m	1110	2400
M2.55 m	1180	2600

Counterweight 6020 13,300

	Reach Boom 6.5 m (21'4")	Reach Boom 6.5 m (21'4")	Reach Boom 6.5 m (21'4")	Mass Boom 6.18 m (20'3")
<b>Stick Length</b>	<b>R3.9 (12'10")</b>	<b>R3.2 (10'6")</b>	<b>R2.8 (9'2")</b>	<b>M2.55E (8'4")</b>
<b>Bucket</b>	<b>1.3 m<sup>3</sup> (1.7 yd<sup>3</sup>)</b>	<b>1.4 m<sup>3</sup> (1.8 yd<sup>3</sup>)</b>	<b>1.5 m<sup>3</sup> (2 yd<sup>3</sup>)</b>	<b>1.7 m<sup>3</sup> (2.2 yd<sup>3</sup>)</b>
<b>1</b> Maximum Reach at Ground Level	11.64 m (38'2")	10.92 m (35'10")	10.62 m (34'10")	10.21 m (33'6")
<b>2</b> Maximum Digging Depth	8.09 m (26'7")	7.39 m (24'3")	6.99 m (22'11")	6.60 m (21'8")
<b>3</b> Minimum Loading Height	2.01 m (6'7")	2.71 m (8'11")	3.11 m (10'2")	2.97 m (9'9")
<b>4</b> Maximum Loading Height	7.64 m (25'1")	7.20 m (23'7")	7.20 m (23'7")	6.67 m (21'11")
<b>5</b> Maximum Vertical Wall Digging Depth	7.35 m (24'1")	6.49 m (21'4")	6.16 m (20'3")	5.85 m (19'2")
<b>6</b> Maximum Cutting Height	10.81 m (35'6")	10.34 m (33'11")	10.35 m (33'11")	10.17 m (33'4")
<b>7</b> Maximum Depth Cut for 2440 mm (8') Level Bottom	7.74 m (25'5")	7.04 m (23'1")	6.64 m (21'9")	6.19 m (20'4")

Bucket Digging Force (ISO/New JIS)	216 kN (48,600 lb)	215 kN (48,300 lb)	214 kN (48,100 lb)	259 kN (58,200 lb)
Bucket Digging Force (SAE/Old JIS)	190 kN (42,700 lb)	190 kN (42,700 lb)	189 kN (42,500 lb)	228 kN (51,300 lb)
Stick Digging Force (ISO/New JIS)	144 kN (32,400 lb)	166 kN (37,300 lb)	185 kN (41,600 lb)	187 kN (42,000 lb)
Stick Digging Force (SAE/Old JIS)	140 kN (31,500 lb)	161 kN (36,200 lb)	180 kN (40,500 lb)	180 kN (40,500 lb)

JC Machinery SUNIGHT

excavatorhunter.com



## 330C Bucket Specifications and Compatibility (600 mm, 24" triple grouser shoes)

	Capacity*		Width		Tip Radius		Weight (w/o tips)		Teeth Qty	Reach			Mass
	m <sup>3</sup>	yd <sup>3</sup>	mm	in	mm	in	kg	lb		R3.9D (12'10")	R3.2D (10'6")	R2.8D (9'2")	
<b>D-Buckets</b>													
Excavation Buckets	1.3	1.7	1345	53	1660	65	1033	2277	5	●	●	●	—
	1.4	1.8	1430	56	1660	65	1075	2370	5	●	●	●	—
	1.4	1.8	1450	57	1703	67	1300	2866	5	●	●	●	—
	1.5	2.0	1500	59	1660	65	1135	2502	5	●	●	●	—
Mass Excavation Buckets	1.6	2.1	1520	60	1660	65	1180	2601	6	●	●	●	—
	1.9	2.5	1700	67	1660	65	1260	2778	6	●	●	●	—
Heavy Duty Buckets	0.7	0.9	775	31	1762	69	985	2172	3	●	●	●	—
	0.9	1.2	925	36	1762	69	1090	2403	3	●	●	●	—
	1.2	1.6	1098	43	1762	69	1200	2646	4	●	●	●	—
	1.4	1.8	1225	48	1762	69	1207	2661	5	●	●	●	—
	1.7	2.2	1400	55	1762	69	1307	2881	5	●	●	●	—
	1.8	2.4	1540	61	1762	69	1408	3104	6	●	●	●	—
	2.0	2.6	1690	67	1762	69	1494	3294	6	○	●	●	—
2.2	2.9	1820	72	1761	69	1650	3638	7	∴	○	●	—	
<b>E-Buckets</b>													
Excavation Buckets	1.7	2.2	1470	58	1845	73	1421	3133	5	—	—	—	●
	1.9	2.5	1560	63	1845	73	1499	3305	5	—	—	—	●
Mass Excavation Buckets	2.1	2.7	1735	68	1845	73	1606	3541	6	—	—	—	●

## 330C L Bucket Specifications and Compatibility (750 mm, 30" triple grouser shoes)

	Capacity*		Width		Tip Radius		Weight (w/o tips)		Teeth Qty	Reach			Mass
	m <sup>3</sup>	yd <sup>3</sup>	mm	in	mm	in	kg	lb		R3.9D (12'10")	R3.2D (10'6")	R2.8D (9'2")	
<b>D-Buckets</b>													
Excavation Buckets	1.3	1.7	1345	53	1660	65	1033	2277	5	●	●	●	—
	1.4	1.8	1430	56	1660	65	1075	2370	5	●	●	●	—
	1.4	1.8	1450	57	1703	67	1300	2866	5	●	●	●	—
	1.5	2.0	1500	59	1660	65	1135	2502	5	●	●	●	—
Mass Excavation Buckets	1.6	2.1	1520	60	1660	65	1180	2601	6	●	●	●	—
	1.9	2.5	1700	67	1660	65	1260	2778	6	●	●	●	—
Heavy Duty Buckets	0.7	0.9	775	31	1762	69	985	2172	3	●	●	●	—
	0.9	1.2	925	36	1762	69	1090	2403	3	●	●	●	—
	1.2	1.6	1098	43	1762	69	1200	2646	4	●	●	●	—
	1.4	1.8	1225	48	1762	69	1207	2661	5	●	●	●	—
	1.7	2.2	1400	55	1762	69	1307	2881	5	●	●	●	—
	1.8	2.4	1540	61	1762	69	1408	3104	6	●	●	●	—
	2.0	2.6	1690	67	1762	69	1494	3294	6	○	●	●	—
2.2	2.9	1820	72	1761	69	1650	3638	7	○	●	●	—	
<b>E-Buckets</b>													
Excavation Buckets	1.7	2.2	1470	58	1845	73	1421	3133	5	—	—	—	●
	1.9	2.5	1560	63	1845	73	1499	3305	5	—	—	—	●
Mass Excavation Buckets	2.1	2.7	1735	68	1845	73	1606	3541	6	—	—	—	●

Assumptions for maximum material density rating:

1. Front linkage fully extended at ground line
2. Bucket curled
3. 100% bucket fill factor

\* Capacities based on SAE J296. Some calculations of capacity fall on borderlines.

Rounding may allow two buckets to have the same English rating, but different metric ratings.

- 2100 kg/m<sup>3</sup> (3500 lbs/yd<sup>3</sup>)
- 1800 kg/m<sup>3</sup> (3000 lbs/yd<sup>3</sup>)
- 1500 kg/m<sup>3</sup> (2500 lbs/yd<sup>3</sup>)
- 1200 kg/m<sup>3</sup> (2000 lbs/yd<sup>3</sup>)
- ∴ 900 kg/m<sup>3</sup> (1500 lbs/yd<sup>3</sup>)
- Not Available

# Reach Boom Lift Capacities



Load Point Height



Load Radius Over Front



Load Radius Over Side



Load at Maximum Reach

**R2.8D STICK** – 2800 mm (9'2")  
**BUCKET** – 1.5 m<sup>3</sup> (1.96 yd<sup>3</sup>)

**UNDERCARRIAGE** – Standard  
**SHOES** – 600 mm (24") triple grouser

**BOOM** – 6500 mm (21'4")

Load Point Height	3.0 m (10.0 ft)		4.5 m (15.0 ft)		6.0 m (20.0 ft)		7.5 m (25.0 ft)		9.0 m (30.0 ft)		m ft		
	Over Front	Over Side	Over Front	Over Side	Over Front	Over Side	Over Front	Over Side	Over Front	Over Side	kg	lb	
9.0 m											*4950	*4950	7.74
7.5 m 25.0 ft							*6900 *15,200	6050 13,350			*4600 *10,200	4450 10,000	9.02 29.32
6.0 m 20.0 ft							*7200 *15,700	5950 12,700			*4500 *9900	3650 8150	9.82 32.08
4.5 m 15.0 ft			*11 600 *24,850	*11 600 *24,850	*9050 *19,550	8500 18,250	*7750 *16,850	5750 12,350	5800 12,800	4050 8850	*4550 *10,000	3250 7150	10.28 33.68
3.0 m 10.0 ft			*14 800 *31,700	12 350 26,600	*10 550 *22,800	7950 17,050	7850 16,900	5500 11,800	5750 12,250	3950 8400	4500 9850	3050 6700	10.46 34.32
1.5 m 5.0 ft			*16 650 *36,500	11 400 24,550	10 850 23,300	7450 16,000	7600 16,300	5250 11,250	5600 12,000	3850 8150	4450 9800	3000 6600	10.38 34.05
Ground Line			16 850 36,150	11 050 23,700	10 500 22,550	7150 15,300	7400 15,850	5050 10,850	5500 11,800	3750 8000	4700 10,300	3150 6950	10.02 32.87
-1.5 m -5.0 ft		*11 000 *25,050	*11 000 *25,050	16 800 36,000	11 000 23,600	10 350 22,250	7000 15,050	7300 15,700	5000 10,650		5250 11,600	3600 7900	9.36 30.66
-3.0 m -10.0 ft		*19 400 *44,050	*19 400 *44,050	*15 650 *33,900	11 150 23,950	10 450 22,400	7050 15,200	7350 15,850	5050 10,850		6450 14,300	4450 9850	8.31 27.13
-4.5 m -15.0 ft		*17 300 *37,250	*17 300 *37,250	*13 000 *27,850	11 550 24,800	*9600 *20,300	7350 15,800				*5900 *13,000	*5900 *13,000	6.70 21.79

\* Limited by hydraulic capacity rather than tipping load. The above loads are in compliance with SAE hydraulic excavator lift capacity rating standard J1097. They do not exceed 87% of hydraulic lifting capacity or 75% of tipping capacity. Weight of all lifting accessories must be deducted from the above lifting capacities.

**R3.9D STICK** – 3900 mm (12'10")  
**BUCKET** – 1.3 m<sup>3</sup> (1.7 yd<sup>3</sup>)

**UNDERCARRIAGE** – Long  
**SHOES** – 750 mm (30") triple grouser

**BOOM** – 6500 mm (21'4")

Load Point Height	1.5 m (5.0 ft)		3.0 m (10.0 ft)		4.5 m (15.0 ft)		6.0 m (20.0 ft)		7.5 m (25.0 ft)		9.0 m (30.0 ft)		m ft			
	Over Front	Over Side	Over Front	Over Side	Over Front	Over Side	Over Front	Over Side	Over Front	Over Side	Over Front	Over Side	kg	lb		
9.0 m 30.0 ft													*3100 *6850	*3100 *6850	9.13 29.53	
7.5 m 25.0 ft													*2900 *6400	*2900 *6400	10.19 33.22	
6.0 m 20.0 ft									*6000 *13,050	*6000 *13,050	*5900 *12,600	4500 9600	*2850 *6250	*2850 *6250	10.89 35.62	
4.5 m 15.0 ft									*6700 *14,550	*6250 13,400	*6200 *13,550	4400 9400	*2900 *6350	2850 6350	11.30 37.04	
3.0 m 10.0 ft					*12 300 *26,400	*12 300 *26,400	*9200 *19,850	8600 18,500	*7600 *16,500	5950 12,700	*6700 *14,550	4250 9100	*3000 *6600	2700 5950	11.46 37.61	
1.5 m 5.0 ft					*15 250 *32,800	12 400 26,750	*10 800 *23,300	8000 17,200	*8550 *18,500	5600 12,000	6950 14,900	4100 8700	*3250 *7100	2650 5850	11.39 37.37	
Ground Line			*6750 *15,400	*6750 *15,400	*16 900 *36,550	11 650 25,100	*11 950 *25,850	7550 16,200	9100 19,550	5300 11,400	6800 14,550	3900 8400	*3600 *7850	2750 6050	11.07 36.32	
-1.5 m -5.0 ft		*6600 *14,700	*6600 *14,700	*10 450 *23,700	*10 450 *23,700	*17 350 *37,550	11 350 24,400	*12 500 *27,050	7300 15,600	8950 19,150	5150 11,050	6700 14,350	3850 8200	*4100 *9050	3050 6650	10.49 34.38
-3.0 m -10.0 ft		*10 800 *24,250	*10 800 *24,250	*15 400 *34,800	*15 400 *34,800	*16 800 *36,300	11 350 24,350	*12 300 *26,600	7200 15,450	8900 19,050	5100 10,950	6700 14,750	3850 8450	*5000 *11,050	3550 7900	9.59 31.35
-4.5 m -15.0 ft		*15 800 *35,600	*15 800 *35,600	*21 600 *46,550	*21 600 *46,550	*15 150 *32,600	11 550 24,800	*11 250 *24,100	7300 15,700	*8400 *17,750	5200 11,200		*6100 *13,400	4700 10,500	8.26 26.83	
-6.0 m -20.0 ft				*16 500 *35,050	*16 500 *35,050	*11 850 *25,100	*11 850 *25,100	*8450 *17,450	7650 16,550				*7250 *15,900	6800 15,500	6.50 20.92	

\* Limited by hydraulic capacity rather than tipping load. The above loads are in compliance with SAE hydraulic excavator lift capacity rating standard J1097. They do not exceed 87% of hydraulic lifting capacity or 75% of tipping capacity. Weight of all lifting accessories must be deducted from the above lifting capacities.

JC Machinery SUNIGHT

excavatorhunter.com

# Reach Boom Lift Capacities



Load Point Height



Load Radius Over Front



Load Radius Over Side



















Load at Maximum Reach

**R3.2D STICK** – 3200 mm (10'6")  
**BUCKET** – 1.5 m<sup>3</sup> (2.0 yd<sup>3</sup>)

**UNDERCARRIAGE** – Long  
**SHOES** – 750 mm (30") triple grouser

**BOOM** – 6500 mm (21'4")















	1.5 m (5.0 ft)		3.0 m (10.0 ft)		4.5 m (15.0 ft)		6.0 m (20.0 ft)		7.5 m (25.0 ft)		9.0 m (30.0 ft)				m ft	
																
9.0 m	kg													*3900	*3900	8.18
7.5 m	kg									*6350	*6350			*3700	*3700	9.38
25.0 ft	lb									*13,950	*13,700			*8100	*8100	30.51
6.0 m	kg									*6700	*6300			*3600	3600	10.14
20.0 ft	lb									*14,650	*13,400			*7950	*7950	33.15
4.5 m	kg							*8500	*8500	*7350	6050	*6750	4250	*3700	3200	10.59
15.0 ft	lb							*18,300	*18,300	*15,950	13,000	*14,650	9100	*8100	*7100	34.69
3.0 m	kg					*13 800	*13 050	*10 050	8350	*8200	5750	7000	4150	*3850	3000	10.76
10.0 ft	lb					*29,650	28,150	*21,650	17,900	*17,700	12,350	15,000	8850	*8500	6600	35.29
1.5 m	kg					*16 300	11 950	*11 450	7800	*8950	5500	6850	4000	*4150	3000	10.67
5.0 ft	lb					*35,100	25,800	*24,700	16,750	*19,400	11,750	14,700	8550	*9150	6550	35.03
Ground Line	kg					*17 300	11 450	*12 300	7400	9050	5250	6750	3900	*4650	3100	10.33
	lb					*37,400	24,600	*26,650	15,900	19,400	11,250	14,450	8300	*10,250	6850	33.89
-1.5 m	kg	*7900	*7900	*11 600	*11 600	*17 150	11 300	*12 550	7250	8900	5150	6700	3850	*5400	3450	9.69
-5.0 ft	lb	*17,600	*17,600	*26,300	*26,300	*37,150	24,300	*27,100	15,550	19,150	11,000	14,750	8450	*11,950	7650	31.76
-3.0 m	kg	*13 300	*13 300	*18 200	*18 200	*16 100	11 450	*12 000	7250	8950	5150			*6700	4250	8.70
-10.0 ft	lb	*29,850	*29,850	*41,300	*41,300	*34,800	24,550	*25,850	15,600	19,200	11,100			*14,700	9350	28.41
-4.5 m	kg			*18 950	*18 950	*13 800	11 750	*10 300	7450					*4700	*4700	7.16
-15.0 ft	lb			*40,800	*40,800	*29,700	25,250	*21,950	16,050					*10,000	*10,000	23.20

\* Limited by hydraulic capacity rather than tipping load. The above loads are in compliance with SAE hydraulic excavator lift capacity rating standard J1097. They do not exceed 87% of hydraulic lifting capacity or 75% of tipping capacity. Weight of all lifting accessories must be deducted from the above lifting capacities.

**R2.8D STICK** – 2800 mm (9'2")  
**BUCKET** – 1.6 m<sup>3</sup> (2.12 yd<sup>3</sup>)

**UNDERCARRIAGE** – Long  
**SHOES** – 750 mm (30") triple grouser

**BOOM** – 6500 mm (21'4")

	3.0 m (10.0 ft)		4.5 m (15.0 ft)		6.0 m (20.0 ft)		7.5 m (25.0 ft)		9.0 m (30.0 ft)				m ft	
														
9.0 m	kg											*4850	*4850	7.77
7.5 m	kg											*4550	*4550	9.04
25.0 ft	lb											*10,050	*10,050	29.38
6.0 m	kg											*4450	3800	9.83
20.0 ft	lb											*9800	8400	32.13
4.5 m	kg			*11 550	*11 550	*9000	8800	*7700	6000	*7050	4200	*4500	3350	10.29
15.0 ft	lb			*24,700	*24,700	*19,400	18,900	*16,700	12,800	*15,500	9250	*9900	7400	33.72
3.0 m	kg			*14 700	12 800	*10 500	8250	*8500	5700	6950	4100	*4700	3150	10.47
10.0 ft	lb			*31,550	27,650	*22,650	17,700	*18,400	12,250	14,900	8750	*10,300	6950	34.34
1.5 m	kg			*16 700	11 850	*11 800	7750	*9250	5450	6850	4000	*5000	3150	10.38
5.0 ft	lb			*36,350	25,550	*25,500	16,650	19,900	11,700	14,650	8500	*11,000	6850	34.07
Ground Line	kg			*17 500	11 500	*12 550	7450	9050	5250	6750	3900	*5550	3300	10.02
	lb			*37,850	24,700	*27,100	15,950	19,450	11,300	14,450	8350	*12,200	7250	32.87
-1.5 m	kg	*10 900	*10 900	*17 050	11 450	*12 550	7300	8950	5200			*6400	3750	9.35
-5.0 ft	lb	*24,750	*24,750	*36,900	24,600	*27,150	15,700	19,250	11,150			*14,100	8200	30.64
-3.0 m	kg	*19 150	*19 150	*15 650	11 600	*11 750	7350	*8850	5250			*6650	4650	8.30
-10.0 ft	lb	*43,550	*43,550	*33,900	24,950	*25,350	15,850	*18,850	11,300			*14,650	10,300	27.09
-4.5 m	kg	*17 400	*17 400	*13 000	12 000	*9600	7600					*5800	*5800	6.76
-15.0 ft	lb	*37,400	*37,400	*27,900	25,800	*20,300	16,450					*12,750	*12,750	22.06

\* Limited by hydraulic capacity rather than tipping load. The above loads are in compliance with SAE hydraulic excavator lift capacity rating standard J1097. They do not exceed 87% of hydraulic lifting capacity or 75% of tipping capacity. Weight of all lifting accessories must be deducted from the above lifting capacities.

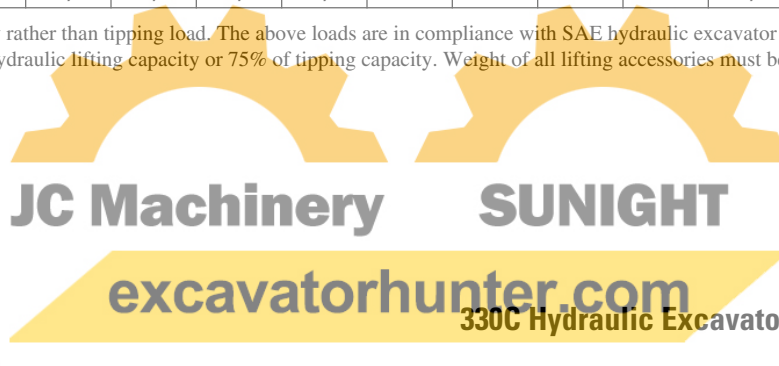



# Reach Boom Lift Capacities



Load Point Height



Load Radius Over Front



Load Radius Over Side



Load at Maximum Reach

**R3.9D STICK** – 3900 mm (12'10")  
**BUCKET** – 1.3 m<sup>3</sup> (1.7 yd<sup>3</sup>)

**UNDERCARRIAGE** – Standard  
**SHOES** – 600 mm (24") triple grouser

**BOOM** – 6500 mm (21'4")

Load Point Height	1.5 m (5.0 ft)		3.0 m (10.0 ft)		4.5 m (15.0 ft)		6.0 m (20.0 ft)		7.5 m (25.0 ft)		9.0 m (30.0 ft)		m ft			
	Over Front	Over Side	Over Front	Over Side	Over Front	Over Side	Over Front	Over Side	Over Front	Over Side	Over Front	Over Side	Over Front	Over Side		
9.0 m 30.0 ft	kg lb												*3100 *6850	*3100 *6850	9.13 29.53	
7.5 m 25.0 ft	kg lb												*2900 *6400	*2900 *6400	10.19 33.22	
6.0 m 20.0 ft	kg lb								*6000 *13,050	*6000 *13,050	*5900 *12,600	4300 9200	*2850 *6250	*2850 *6250	10.89 35.62	
4.5 m 15.0 ft	kg lb								*6700 *14,550	6000 12,850	6050 12,850	4200 9000	*2900 *6350	2700 6000	11.30 37.04	
3.0 m 10.0 ft	kg lb				*12 300 *26,400	*12 300 *26,400	*9200 *19,850	8250 17,800	*7600 *16,500	5700 12,150	5850 12,500	4050 8650	*3000 *6600	2550 5600	11.46 37.61	
1.5 m 5.0 ft	kg lb				*15 250 *32,800	11 950 *23,700	*10 800 *23,300	7650 16,450	7700 16,550	5350 11,450	5650 12,100	3900 8250	*3250 *7100	2500 5500	11.39 37.37	
Ground Line	kg lb			*6750 *15,400	*6750 *15,400	*16 900 36,550	11 200 24,050	10 600 22,750	7200 15,500	7400 15,900	5100 10,900	5500 11,800	3750 7950	*3600 *7850	2600 5700	11.07 36.32
-1.5 m -5.0 ft	kg lb	*6600 *14,700	*6600 *14,700	*10 450 *23,700	*10 450 *23,700	16 700 35,750	10 900 23,350	10 300 22,150	6950 14,900	7250 15,500	4900 10,500	5400 11,600	3650 7750	*4100 *9050	2850 6300	10.49 34.38
-3.0 m -10.0 ft	kg lb	*10 800 *24,250	*10 800 *24,250	*15 400 *34,800	*15 400 *34,800	16 700 35,700	10 850 23,300	10 250 21,950	6900 14,750	7200 15,400	4850 10,400	5400 11,900	3650 8000	*5000 *11,050	3400 7500	9.59 31.35
-4.5 m -15.0 ft	kg lb	*15 800 *35,600	*15 800 *35,600	*21 600 *46,550	*21 600 *46,550	*15 150 *32,600	11 050 23,750	10 350 22,250	7000 15,000	7300 15,700	4950 10,700			*6100 *13,400	4500 10,050	8.26 26.83
-6.0 m -20.0 ft	kg lb			*16 500 *35,050	*16 500 *35,050	*11 850 *25,100	11 550 24,800	*8450 *17,450	7350 15,850					*7250 *15,900	6550 14,850	6.50 20.92

\* Limited by hydraulic capacity rather than tipping load. The above loads are in compliance with SAE hydraulic excavator lift capacity rating standard J1097. They do not exceed 87% of hydraulic lifting capacity or 75% of tipping capacity. Weight of all lifting accessories must be deducted from the above lifting capacities.

**R3.2D STICK** – 3200 mm (10'6")  
**BUCKET** – 1.4 m<sup>3</sup> (1.83 yd<sup>3</sup>)

**UNDERCARRIAGE** – Standard  
**SHOES** – 600 mm (24") triple grouser

**BOOM** – 6500 mm (21'4")

Load Point Height	1.5 m (5.0 ft)		3.0 m (10.0 ft)		4.5 m (15.0 ft)		6.0 m (20.0 ft)		7.5 m (25.0 ft)		9.0 m (30.0 ft)		m ft			
	Over Front	Over Side	Over Front	Over Side	Over Front	Over Side	Over Front	Over Side	Over Front	Over Side	Over Front	Over Side	Over Front	Over Side		
9.0 m	kg												*3950	*3950	8.18	
7.5 m 25.0 ft	kg lb								*6400 *14,050	6200 13,300			*3700 *8200	*3700 *8200	9.38 30.51	
6.0 m 20.0 ft	kg lb								*6750 *14,750	6100 13,000			*3650 *8050	3500 7750	10.14 33.15	
4.5 m 15.0 ft	kg lb						*8550 *18,400	*8550 *18,400	*7400 *16,050	5850 12,550	5900 12,600	4100 8750	*3750 *8200	3100 6800	10.59 34.69	
3.0 m 10.0 ft	kg lb				*13 850 *29,750	12 600 27,200	*10 100 *21,750	8050 17,300	7950 17,050	5550 11,950	5800 12,350	4000 8500	*3900 *8550	2900 6350	10.76 35.29	
1.5 m 5.0 ft	kg lb				*16 350 *35,200	11 500 24,800	10 900 23,400	7500 16,100	7650 16,350	5250 11,300	5650 12,050	3850 8200	*4200 *9250	2850 6250	10.67 35.03	
Ground Line	kg lb			*13,850	*13,850	16 850 36,100	11 000 23,650	10 500 22,550	7100 15,300	7400 15,850	5050 10,800	5500 11,800	3750 8000	4450 9750	3000 6550	10.33 33.89
-1.5 m -5.0 ft	kg lb	*7950 *17,700	*7950 *17,700	*11 700 *26,400	*11 700 *26,400	16 700 35,750	10 850 23,350	10 300 22,150	6950 14,950	7250 15,600	4950 10,600	5450 12,050	3700 8100	4950 10,850	3350 7350	9.69 31.76
-3.0 m -10.0 ft	kg lb	*13 400 *29,950	*13 400 *29,950	*18 300 *41,400	*18 300 *41,400	*16 100 *34,900	11 000 23,600	10 300 22,150	6950 14,950	7300 15,650	4950 10,650			5950 13,150	4050 9000	8.70 28.41
-4.5 m -15.0 ft	kg lb			*19 000 *40,850	*19 000 *40,850	*13 850 *29,800	11 300 24,300	*10 350 *22,050	7150 15,450					*4700 *10,000	*4700 *10,000	7.16 23.20

\* Limited by hydraulic capacity rather than tipping load. The above loads are in compliance with SAE hydraulic excavator lift capacity rating standard J1097. They do not exceed 87% of hydraulic lifting capacity or 75% of tipping capacity. Weight of all lifting accessories must be deducted from the above lifting capacities.

JC Machinery SUNIGHT

excavatorhunter.com

# Mass Excavation Boom Lift Capacities



Load Point Height



Load Radius Over Front



Load Radius Over Side



Load at Maximum Reach

**M2.55E STICK** – 2550 mm (8'4")  
**BUCKET** – 1.7 m<sup>3</sup> (2.22 yd<sup>3</sup>)

**UNDERCARRIAGE** – Standard  
**SHOES** – 600 mm (24") triple grouser

**BOOM** – 6180 mm (20'3")

Diagram	3.0 m (10.0 ft)		4.5 m (15.0 ft)		6.0 m (20.0 ft)		7.5 m (25.0 ft)		Diagram		m ft	
	Front	Side	Front	Side	Front	Side	Front	Side	Front	Side		
7.5 m 25.0 ft	kg lb								*3900 *8650	*3900 *8650	8.50 27.59	
6.0 m 20.0 ft	kg lb				*8050 *17,450	*8050 *17,450	*7500 *16,300	5650 12,100	*3850 *8400	*3800 *8400	9.35 30.53	
4.5 m 15.0 ft	kg lb		*11 650 *25,000	*11 650 *25,000	*9200 *19,850	8300 17,850	7900 16,950	5550 11,800	*3900 *8550	3300 7350	9.83 32.18	
3.0 m 10.0 ft	kg lb		*14 700 *31,500	12 300 26,450	*10 600 *22,900	7800 16,700	7650 16,450	5300 11,350	*4100 *8950	3100 6800	10.00 32.79	
1.5 m 5.0 ft	kg lb		*16 800 *36,200	11 300 24,350	10 700 23,000	7300 15,650	7400 15,900	5050 10,850	*4400 *9700	3100 6800	9.88 32.44	
Ground Line	kg lb		16 750 35,900	10 900 23,450	10 350 22,250	7000 15,000	7250 15,500	4900 10,500	4950 10,900	3300 7250	9.48 31.09	
-1.5 m -5.0 ft	kg lb	*14 500 *32,850	*14 500 *32,850	16 700 35,800	10 900 23,350	10 250 22,000	6900 14,800	7200 15,400	4850 10,400	5700 12,600	3850 8500	8.73 28.60
-3.0 m -10.0 ft	kg lb	*20 450 *44,350	*20 450 *44,350	*15 050 *32,500	11 100 23,800	10 350 22,250	7000 15,000		*6500 *14,250	5100 11,350	7.53 24.55	
-4.5 m -15.0 ft	kg lb	*15 500 *33,150	*15 500 *33,150	*11 650 *24,750	11 550 *24,750				*8050 *17,600	7500 16,950	5.93 19.20	

\* Limited by hydraulic capacity rather than tipping load. The above loads are in compliance with SAE hydraulic excavator lift capacity rating standard J1097. They do not exceed 87% of hydraulic lifting capacity or 75% of tipping capacity. Weight of all lifting accessories must be deducted from the above lifting capacities.

**M2.55E STICK** – 2550 mm (8'4")  
**BUCKET** – 1.9 m<sup>3</sup> (2.5 yd<sup>3</sup>)

**UNDERCARRIAGE** – Long  
**SHOES** – 750 mm (30") triple grouser

**BOOM** – 6180 mm (20'3")

Diagram	3.0 m (10.0 ft)		4.5 m (15.0 ft)		6.0 m (20.0 ft)		7.5 m (25.0 ft)		Diagram		m ft	
	Front	Side	Front	Side	Front	Side	Front	Side	Front	Side		
7.5 m 25.0 ft	kg lb								*3850 *8550	*3850 *8550	8.50 27.59	
6.0 m 20.0 ft	kg lb				*8000 *17,350	*8000 *17,350	*7400 *16,200	5850 12,500	*3750 *8300	*3750 *8300	9.35 30.53	
4.5 m 15.0 ft	kg lb		*11 600 *24,900	*11 600 *24,900	*9150 *19,750	8600 18,450	*7850 *17,100	5750 12,250	*3850 *8400	3450 7600	9.83 32.18	
3.0 m 10.0 ft	kg lb		*14 650 *31,400	12 750 27,400	*10 550 *22,800	8050 17,300	*8550 *18,550	5500 11,750	*4000 *8800	3200 7100	10.00 32.79	
1.5 m 5.0 ft	kg lb		*16 750 *36,050	11 750 25,300	*11 800 *25,450	7600 16,300	9100 19,450	5250 11,250	*4350 *9600	3200 7050	9.88 32.44	
Ground Line	kg lb		*17 300 *37,450	11 350 24,350	*12 400 *26,850	7250 15,600	8900 19,050	5100 10,900	*4900 *10,800	3450 7550	9.48 31.09	
-1.5 m -5.0 ft	kg lb	*14 400 *32,700	*14 400 *32,700	*16 700 *36,150	11 300 24,300	*12 300 *26,550	7150 15,400	8850 18,950	5050 10,800	*5850 *12,900	4000 8850	8.73 28.60
-3.0 m -10.0 ft	kg lb	*20 400 *44,200	*20 400 *44,200	*15 000 *32,400	11 550 24,750	*11 150 *23,950	7250 15,600		*6450 *14,100	5300 11,800	7.53 24.55	
-4.5 m -15.0 ft	kg lb	*15 450 *33,050	*15 450 *33,050	*11 600 *24,600	*11 600 *24,600				*8000 *17,450	7800 *17,450	5.93 19.20	

\* Limited by hydraulic capacity rather than tipping load. The above loads are in compliance with SAE hydraulic excavator lift capacity rating standard J1097. They do not exceed 87% of hydraulic lifting capacity or 75% of tipping capacity. Weight of all lifting accessories must be deducted from the above lifting capacities.



## Standard Equipment

*Standard and optional equipment may vary. Consult your Caterpillar dealer for specifics.*

### Electrical

- Alternator, 70A
- Boom Lights, Right and Left Side
- Horn, Signaling/Warning
- Working Light, Frame Mounted

### Operator Environment

- Bolt-on FOGS Capability
- Cab
  - Ashtray with Lighter
  - Beverage Holder
  - Bi-level Air Conditioner
    - with Auto Climate Control And Defroster
  - Coat Hook
  - Floor Mat, Washable
  - Hydraulic Neutralizer Lever for All Controls
  - Joystick Type Controls, Pilot Operated
  - Language Display Monitor with Gauges
    - Warning Messages
    - Filter/Fluid Change Information
    - Start-up Fluid Level Check for:
      - Hydraulic Oil
      - Engine Oil and Coolant
    - Working Hour Information
    - Machine Condition
    - Error Code and Tool Mode Setting Information
    - Full Time Clock
  - Light, Interior
  - Literature Holder
  - Pop-up Skylight, Polycarbonate with Sunshade
  - Positive Filtered Ventilation
  - Pressurized Cab
  - Radio Ready Cab
    - Pre-wired Mounting Areas
    - Speakers
    - 24V to 12V Converter
    - Antennae
  - Rear Window, Emergency Exit
  - Removable Lower Window with in-cab storage bracket
  - Retractable Front Windshield with Assist Device
  - Seat, Suspension Type
    - Four-way Adjustable
    - Adjustable Armrests - 95 mm (3.74") wide
    - Retractable Seatbelt - 76 mm (3.0") wide
  - Sliding Upper Door Window
  - Storage Compartment
  - Travel Control Pedals with Removable Hand Levers
    - Capability to install two additional pedals
  - Windshield Wiper with Washer, Pillar Mounted Upper
  - Windshield Split by 7:3, Front

### Power Train

- Cat C9 Diesel Engine
  - Air Intake Heater
  - Air-to-air Aftercooling (ATAAC)
  - 24V Electric Starting
  - HEUI™ Fuel System
  - Tier II Emissions Package
- 2300 m (7500 ft) Altitude Capability
- Automatic Engine Speed Control
  - One Touch Low Idle
- Cooling
  - Protection of 43° C to -18° C at 50% Concentration
- Straight Line Travel
- Two Speed Auto-shift Travel
- Two 2-Micron Fuel Filters
- Water Separator in fuel line

### Undercarriage

- Hydraulic Track Adjusters
- Idler and Center Section Track Guiding Guards
- Towing Eye on Baseframe
- Track-type Undercarriage with Grease Lubricated Seals
  - 600 mm (24") Triple Grouser Shoes - 330C
  - 750 mm (30") Triple Grouser Shoes - 330C L

### Other Standard Equipment

- Adopt Cat data link with capability of using Cat ET
- Automatic Swing Parking Brake
- Automatic Work Modes
- Auxiliary Hydraulic Valve (one)
- Boom Drift Reducing Valve
- Boom Lowering Device for Backup
- Capability of Stackable Valve for Main Valve
  - (Maximum of Three Valves)
- Capability of Auxiliary Circuit
  - (Aux. Pump and Valves)
- Capability of Boom and Stick Lowering Control Device
- Capability of Bio using Hydraulic Oil System
- Counterweight with Lifting Eyes 6020 kg (13,300 lb)
- Door Locks and Caps Locks with One-key Security System
- Mirrors (Frame-right, Cab-left)
- Regeneration Circuit for Boom and Stick
- Reverse Swing Damping Valve
- Steel Wall between Engine and Pump Compartment
- Stick Drift Reducing Valve
- Wave Fin Radiator





## Optional Equipment

Standard and optional equipment may vary. Consult your Caterpillar dealer for specifics.

### Mandatory in Certain Countries

- Cab with Tempered Windows
  - Front Windshield, Laminated
- Monitor with Asian Language, Including:
  - English
  - Indonesian
  - Chinese
  - Thai
  - Japanese

### Electrical

- Electric Refueling Pump
- Mounted Working Lights
- Power Supply, 12V-10A
  - 1 or 2 Sockets
- Travel Alarm

### Hydraulic

- Auxiliary Hydraulic Lines for Booms and Sticks
- Pump Flow Controls
- 3 Auxiliary Hydraulic Arrangement Options  
(\*Including Boom and Stick Lines)
  - Hammer Circuit
  - Thumb Circuit
  - Combined Circuit

### Operator Environment

- Bolt-on FOGS
- Cab
  - Fan
  - Hand Control Pattern Changer
  - Heater and Defroster without AC
  - Rain Protector, Cab Front
- Seat
  - High Back
  - High Back and Seat Heater
  - Headrest
- Storage Compartment with Lid
- Straight Travel Third Pedal
- Sun Visor, Windshield
- Windshield Wiper with Washer, Lower Windows
  - Polycarbonate

### Power Train

- Cooling System
  - High Ambient Cooling Package (up to 52° C)
- Starting Aid
  - Cold Weather (down to -32° C)
- Water Separator Level Indicator

### Undercarriage

- Sprocket Guiding Guard
- Track Guiding Guard, Full Length
- Track Options
  - 600 mm (24") Triple Grouser Shoes
  - 750 mm (30") Triple Grouser Shoes
  - 850 mm (34") Triple Grouser Shoes

### Other Optional Equipment

- Air Prefilter
- Buckets
  - Side cutters and tips
- Bucket Linkage
  - D-family - Reach
  - E-family - Mass
- Drive for Auxiliary Pump
- Fine Swing Control
- Guards
  - Bottom, Heavy Duty
  - Cab Top
  - Upper and Lower Front Windshield
  - Vandalism Protection
- Rubber Bumpers
- Stick and Boom Combinations:
  - Reach Boom 6.5 m (21'4")
  - Heavy Duty Reach Boom 6.5 m (21'4")
    - R3.9D 3900 mm (12'10")
    - R3.2D 3200 mm (10'6")
    - R2.8D 2800 mm (9'2")
    - R3.2D HD 3300 mm (10'10")
    - R2.8D HD 2800 mm (9'2")
  - Mass Boom 6.18 m (20'3")
    - M2.6E 2600 mm (8'6")

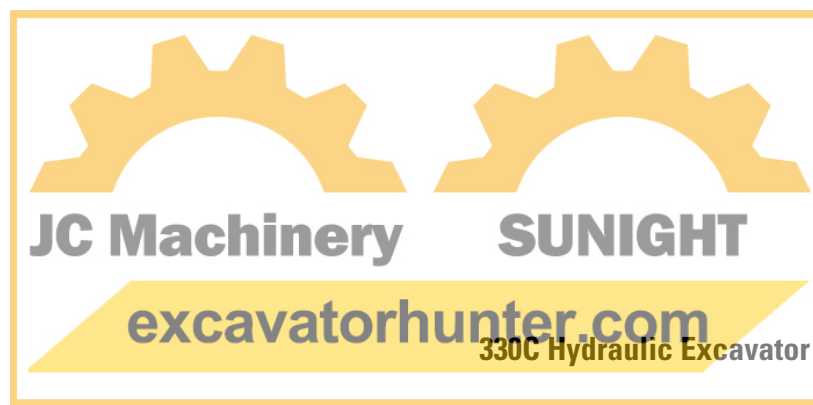



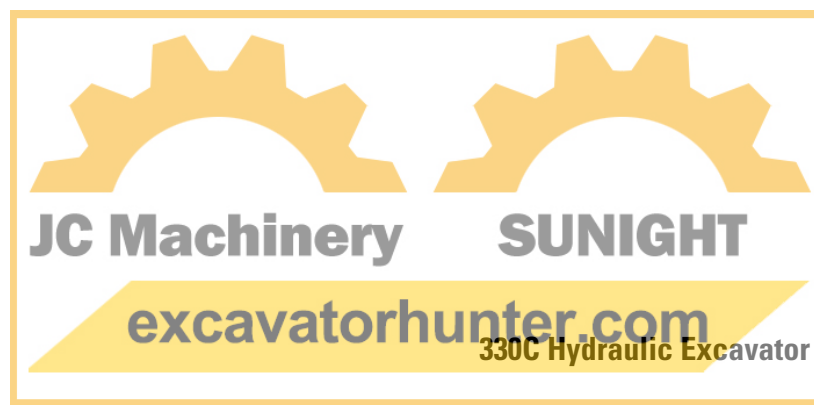



# 330C Hydraulic Excavator

For more complete information on Cat products, dealer services, and industry solutions, visit us on the web at [www.CAT.com](http://www.CAT.com)

© 2001 Caterpillar  
Printed in U.S.A.

AEHQ5452 (10-01)

(CAPL/COFA/CCL) Replaces AEHQ5176

Materials and specifications are subject to change without notice.  
Featured machines in photos may include additional equipment.  
See your Caterpillar dealer for available options.

