



336D/ 336D L

Hydraulic Excavator



JC Machinery

excavatorhunter.com

Engine

Engine Model

Cat® C9 with
ACERT™ Technology

Net Flywheel Power

200 kW

Weights

Operating Weight –
Std. Undercarriage

33 750 kg

Operating Weight –
Long Undercarriage

35 020 kg

336D/336D L Hydraulic Excavator

The D Series incorporates innovations for improved performance and versatility.

Engine

- ✓ The C9 with ACERT™ Technology offers better fuel efficiency and reduced wear. It works at the point of combustion to optimize engine performance and provide low exhaust emissions. By combining ACERT Technology with the new Economy Mode and Power Management, customers can balance the demands of performance and fuel economy to suit their requirements and application. **pg. 4**

Service and Maintenance

Fast, easy service has been designed in with extended service intervals, advanced filtration, convenient filter access and user-friendly electronic diagnostics for increased productivity and reduced maintenance costs. **pg. 12**

Hydraulics

The hydraulic system has been designed to provide reliability and outstanding controllability. An optional Tool Control System provides enhanced flexibility. **pg. 5**

Complete Customer Support

Your Cat® dealer offers a wide range of services that can be set up under a customer support agreement when you purchase your equipment. The dealer will help you choose a plan that can cover everything from machine configuration to eventual replacement. **pg. 13**

Operator Station

- ✓ Provides maximum space, wider visibility and easy access to switches. The monitor is a full-color graphical display that allows the operator to understand the machine information easily. Overall, the new cab provides a comfortable environment for the operator. **pg. 6**



JC Machinery **SUNIGHT**
excavatorhunter.com

Structures

Caterpillar® design and manufacturing techniques assure outstanding durability and service life from these important components. **pg. 8**

Booms and Sticks

Three lengths of booms and eight sticks are available to suit a variety of application conditions. **pg. 9**

Work Tools – Attachments

✓ A variety of work tools, including buckets, couplers, hammers, and shears are available through Cat Work Tools. **pg. 10**



JC Machinery **SUNIGHT** ✓ *New Feature*
excavatorhunter.com

Engine

The Cat® C9 gives the 336D exceptional power and fuel efficiency unmatched in the industry for consistently high performance in all applications.



Cat C9. The Cat C9 with ACERT™ Technology introduces a series of evolutionary, incremental improvements that provide breakthrough engine technology. The building blocks of ACERT Technology are fuel delivery, air management and electronic control. ACERT Technology optimizes engine performance while meeting local engine emission regulations for off-road applications. By combining ACERT Technology with the new Economy Mode, customers can balance the demands of performance and fuel economy to suit their requirements and application.

Performance. The 336D/336D L, equipped with a C9 with ACERT Technology, provides 9% more horsepower as compared to the C9 in the 330C/330C L.

Power Management. Optimizes machine performance for each type of application. The operator can change the engine power on the monitor (password protected) from standard to high. The high power mode is recommended for extremely productive and hard digging applications. The standard power mode is recommended for lighter duty applications and optimizes fuel efficiency.

Automatic Engine Speed Control. The two-stage, one-touch control maximizes fuel efficiency and reduces sound levels.

ADEM™ A4 Engine Controller.

The ADEM A4 electronic control module manages fuel delivery to get the best performance per liter of fuel used. The engine management system provides flexible fuel mapping, allowing the engine to respond quickly to varying application needs. It tracks engine and machine conditions while keeping the engine operating at peak efficiency.

Fuel Delivery. The Cat C9 features electronic controls that govern the unit fuel injection system. Multiple injection fuel delivery involves a high degree of precision. Precisely shaping the combustion cycle lowers combustion chamber temperatures, generating fewer emissions and optimizing fuel combustion. This translates into more work output for your fuel cost.

Cooling System. The cooling fan is hydraulically driven with a variable speed control that manages fan speed to provide optimized cooling. The optimum fan speed is calculated based on the target engine speed, coolant temperature, hydraulic oil temperature and actual fan speed. The Cat C9 delivered a completely new layout that separates the cooling system from the engine compartment.

Air Cleaner. The radial seal air filter features a double-layered filter core for more efficient filtration and is located in a compartment behind the cab. A warning is displayed on the monitor when dust accumulates above a preset level.

Noise Reduction Technologies.

The engine mounts are rubber-isolating mounts matched with the engine package. Further noise reduction has been achieved through design changes to the isolated top cover, oil pan, multiple injection strategy, insulated timing cover, sculpted crankcase and gear train refinements.



Hydraulics

Cat hydraulics delivers power and precise control to keep material moving.

Component Layout. The 336D hydraulic system and component locations have been designed to provide a high level of system efficiency. The main pumps, control valves and hydraulic tank are located close together to allow for shorter tubes and lines between components, which reduce friction loss, and pressure drops in the lines. The layout further provides greater operator comfort by placing the radiator on the cab side of the upper structure. This allows incoming air to enter the engine compartment from the operator side and hot air and corresponding engine sound to exit on the opposite side away from the operator. This reduces engine compartment heat and sound being transmitted to the operator.

Pilot System. The pilot pump is independent from the main pumps and controls the front linkage, swing and travel operations.

Hydraulic Cross Sensing System. The hydraulic cross sensing system utilizes each of two hydraulic pumps to 100 percent of engine power, under all operating conditions. This improves productivity with faster implement speeds and quicker, stronger pivot turns.

Boom and Stick Regeneration Circuit. Boom and stick regeneration circuit saves energy during boom-down and stick-in operation which increases efficiency, reduces cycle times and pressure loss for higher productivity, lower operating costs and increased fuel efficiency.



Auxiliary Hydraulic Valve. The auxiliary valve is standard on the 336D. Control Circuits are available as attachments, allowing for operation of high and medium pressure tools such as shears, grapples, hammers, pulverizers, multi-processors and vibratory plate compactors.

Hydraulic Cylinder Snubbers. Snubbers are located at the rod-end of the boom cylinders and both ends of the stick cylinders to cushion shocks while reducing sound levels and extending component life.



Operator Station

Designed for comfort, simple and easy operation, the 336D allows the operator to focus on production.



JC Machinery

SUNIGHT

excavatorhunter.com

Operator Station. The workstation is spacious, quiet and comfortable, assuring high productivity during a long workday. The air conditioner and attachment switches are conveniently located on the right-hand wall, and the key switch and throttle dial are on the right-hand console. The monitor is mounted in front of the right front cab post and is easy to see.

Standard Cab Equipment. To enhance operator comfort and productivity, the cab includes a lighter, drink holder, coat hook, service meter, literature holder, magazine rack and storage compartment.



Monitor. The monitor is a full color 400x234 pixels Liquid Crystal Display (LCD) graphic display. The monitor angle can be adjusted to minimize sun glare and has the capability of displaying information in twenty-seven different languages.

The Master Caution Lamp blinks ON and OFF when one of the critical conditions below occurs:

- Engine oil pressure low
- Coolant temperature high
- Hydraulic oil temperature high

Under normal conditions or the default condition, the monitor display screen is divided into four areas; clock and throttle dial, gauge, event display and multi-information display.

Clock and Throttle Dial Display.

The clock and throttle dial position are displayed in this area. When Economy mode/Power management system is activated, the icon of the gas station icon will be indicated at the side of the throttle dial.

Gauge Display. Three analog gauges, fuel level, hydraulic oil temperature and coolant temperature, are displayed in this area.

Event Display. Machine information is displayed in this area with the icon and language.

Multi-information Display. This area is reserved for displaying various information that is convenient for the operator. The “CAT” logo mark is displayed when no information is available to be displayed.

Joystick Control. Joystick controls have low lever effort and are designed to match the operator’s natural wrist and arm position. The operator can operate joystick controls with an arm on the armrest and the horizontal and vertical strokes have been designed to reduce operator fatigue.

Seat. A new optional air suspension seat is available in the 336D. The standard and optional seats provide a variety of adjustments to suit the operator’s size and weight including fore/aft, height and weight. Wide adjustable armrests and a retractable seat belt are also included.

Hydraulic Activation Control Lever.

For added safety, this lever must be in the operate position to activate the machine control functions.

Climate Control. Positive filtered ventilation with a pressurized cab is standard. Fresh air or re-circulated air can be selected with a switch on the left console.



Console. Redesigned consoles feature a simple, functional design to reduce operator fatigue, ease of switch operation and excellent visibility. Both consoles have attached armrests with height adjustments.

Cab Exterior. The exterior design uses thick steel tubing along the bottom perimeter of the cab, improving the resistance of fatigue and vibration. This design allows the FOGS to be bolted directly to the cab, at the factory or as an attachment later, enabling the machine to meet specifications and job site requirements.

Cab Mounts. The cab shell is attached to the frame with viscous rubber cab mounts, which dampen vibrations and sound levels while enhancing operator comfort.

Windows. To promote visibility, all glass is affixed directly to the cab, eliminating window frames. The upper front windshield opens, closes and stores on the roof above the operator with a one-touch action release system.

Wipers. Pillar-mounted wipers increase the operator’s viewing area and offer continuous and intermittent modes.

Skylight. An enlarged skylight with sunshade provides excellent visibility and excellent ventilation.

Product Link. Product Link is now an attachment available from the factory.

Structures

336D structural components and undercarriage are the backbone of the machine's durability.

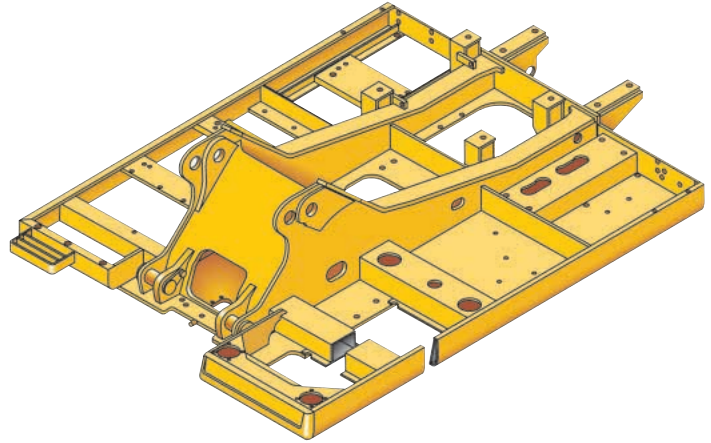
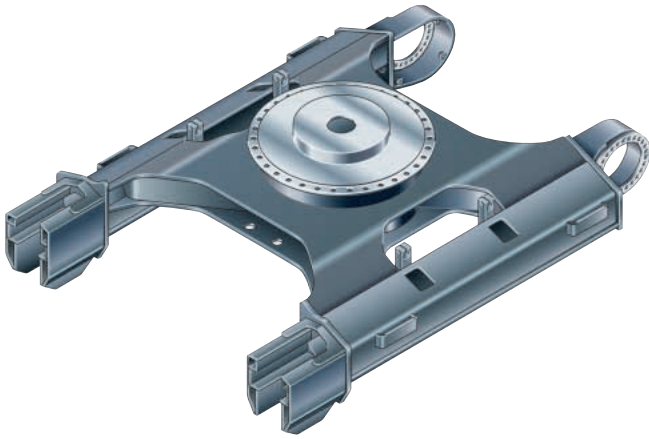

Robotic Welding. Up to 95% of the structural welds on a Caterpillar® Excavator are completed by robots. Robotic welds achieve over three times the penetration of manual welds.

Carbody Design and Track Roller Frames. X-shaped, box-section carbody provides excellent resistance to torsion bending. Robot-welded track roller frames are press-formed, pentagonal units to deliver exceptional strength and service life.

Main Frame. Rugged main frame is designed for maximum durability and efficient use of materials.

Undercarriage. Durable Cat undercarriage absorbs stresses and provides excellent stability.

Rollers and Idlers. Sealed and lubricated track rollers, carrier rollers, and idlers provide excellent service life, to keep the machine in the field longer.

Standard Undercarriage. The standard undercarriage is well suited for applications that require frequent repositioning of the machine, have restricted working space or uneven, rocky terrain.

Long Undercarriage. The long (L) undercarriage maximizes stability and lift capacity. This long, wide, and sturdy undercarriage offers a very stable work platform.



JC Machinery

SUNIGHT

excavatorhunter.com

Booms and Sticks

Designed-in flexibility to help bring higher production and efficiency to all jobs.

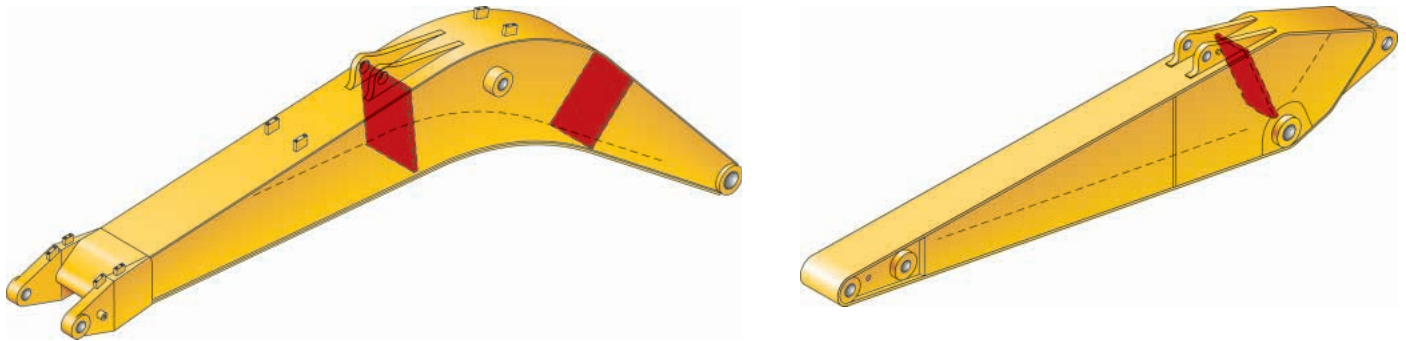

Booms, Sticks and Attachments.

Designed for maximum flexibility, productivity and high efficiency on all jobs, the 336D offers a wide range of configurations suitable for a variety of applications.

Front Linkage Attachments. Three lengths of booms and eight sticks are available, offering a range of configurations suitable for a wide variety of application conditions.

Booms. The booms have large cross-sections and internal baffle plates to provide long life durability.

Sticks. The sticks are made of high-tensile strength steel using a large box section design with interior baffle plates and an additional bottom guard.

Reach Boom. The reach boom features an optimum design that maximizes digging envelopes with four stick choices:

R3.9DB, R3.2DB and R2.8DB Sticks

- The DB-family bucket associated with these sticks have enough capacity for excellent reach and depth in trenching and general construction applications.

R3.9DB Stick

- Suited for the high-capacity buckets used in trenching, excavation, and other general construction work. Designed with enough reach and depth to match a large-capacity bucket and high digging force.

R3.2DB Stick

- This stick provides the most versatile front linkage. The R3.2DB is an excellent fit for all 11-ton to 32 ton dump trucks with regard to reach and bucket capacity.

R2.8DB Stick

- Designed with enough reach and depth to match a large-capacity bucket and high digging force. Suitable for the high-capacity buckets used in trenching, excavation and other general construction work.

R2.15TB1 Stick

- This stick was designed particularly for large capacity-construction work.

Mass Excavation Boom. The mass excavation boom maximizes productivity. The mass version offers significantly higher digging forces and allows use of larger buckets.

M2.55TB1 and M2.15TB1 Sticks

- The TB1 Sticks use a TB-family bucket and were designed for high volume earth moving, powerful digging force and a large capacity bucket. Combined with a Mass boom, these sticks deliver outstanding productivity.

Linkage Pins. The bucket linkage pins have been enlarged to improve reliability and durability. All the pins in the front linkages have thick chrome plating, giving them high wear and corrosion resistance.

Bucket Linkage. The power link improves durability, increases machine-lifting capability in key lifting positions and is easier to use than compared to the previous lifting eye.



Work Tools – Attachments

The 336D has an extensive selection of work tools to optimize machine performance.

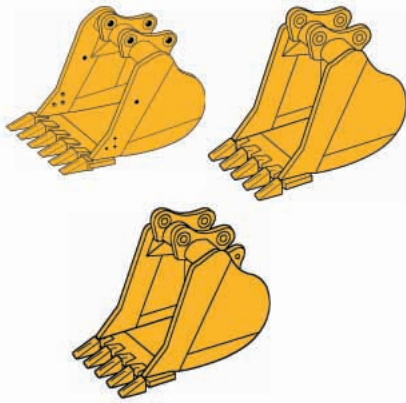

Service Life. Caterpillar buckets increase service life and reduce repair costs.

- Dual radius design for increased heel clearance and reduced wear
- Robot welding of hinge assembly for increased weld penetration and longer life
- Incorporates the new aggressive and easier to install, K Series™ GET tool system
- High strength and heat-treated steel that exceeds T-1 in high wear areas

Excavation Buckets (X). Excavation (X) buckets for digging in low-impact, moderately abrasive materials such as dirt, loam, gravel and clay.

Heavy-Duty Buckets. Heavy duty (HD) buckets for a wide range of moderately abrasive applications such as mixed dirt, clay and rock. HD buckets have best loading and dumping characteristics and will empty easier in cohesive material. More robust construction than the GP buckets.

Heavy-Duty Power (HDP) Buckets.

For use in moderately abrasive applications where breakout force and cycle times are critical. Maximizes tip force and improves cycle times in most materials. Not for use in sticky material conditions. Cutting edge and GET are up-sized.

Heavy-Duty Rock Buckets. Heavy-duty rock for aggressive bucket loading in highly abrasive application such as shot rock and granite. Features include:

- Thickest wear plates to extend the life of bucket in severe applications
- Side wear plated extend further up the side of the bucket for maximum protection in rocky soils
- Buckets accept sidebar protectors for best sidebar protection, or side cutters for best fill characteristics and bucket wear protection

Caterpillar Ground Engaging Tools (GET).

The new Caterpillar K Series GET is featured on the new buckets. This new GET system uses a hammerless vertical retainer, which is easier to remove and install than the Cat J Series pin. The new tooth shapes are more aggressive and offer better penetration than the previous generation of tips. There are also a variety of side cutters and sidebar protectors to match operating conditions.



Tool Control System. The optional tool control system maximizes work tool productivity by configuring hydraulic flow, pressure, and operator controls to match a specific work tool. System versatility enables a wide range of tools to be used.



Versatility

A wide variety of optional factory-installed attachments are available to enhance performance and improve job site management.



Thumb

Cat® thumbs multiply the capabilities of your excavator. This highly flexible tool works in conjunction with the bucket to transform an excavator into a highly versatile material-handling machine.



Hammer

Cat Hydraulic Hammers are precisely matched to Cat machines for optimum performance in a wide variety of demolition and construction applications.



Multi-processor

Multi-processors do the work of many types of demolition tools by use of interchangeable jaw sets. Changing jaws allows a single unit to crush, pulverize and perform a variety of specialized cutting tasks, such as cutting steel rebar and tanks.



Vibratory Plate Compactor

Caterpillar® Vibratory Plate Compactors provide superior compaction force in a reliable, low-maintenance package. These units produce high-power impulses at a rate of 2,200 impacts per minute. The forces generated by this vibration drive soil particles close together for solid, stable compactions. Whether in a trench or on a slope, driving sheeting or posts, Cat Compactors are the superior choice for any jobsite's compaction tasks.



360° Scrap Shear

Caterpillar Scrap Shears feature 360° rotation and high force-to-weight ratio. Used for demolishing steel structures and preparing bulk scrap (such as cars, farm machinery and railroad cars) for further processing.



Pin-Grabber Quick Coupler

Pin-Grabber Plus Quick Couplers multiply the versatility and utility of Cat Excavators by allowing them to pick up and use virtually any work tool equipped with standard pins.

Dedicated Quick Coupler. Quick Couplers increase the versatility of Cat excavators; allowing the ease of changing work tools to meet job requirements at hand in a matter of minutes or seconds. Dedicated quick coupler buckets have no loss of tip radius, and develop maximum breakout force.

Service and Maintenance

Simplified service and maintenance features save you time and money.



Ground Level Service. The design and layout of the 336D was made with the service technician in mind. Many service locations are easily accessible at ground level allowing critical maintenance to get done quickly and efficiently.

Air Filter Compartment. The air filter features a double-element construction for superior cleaning efficiency. When the air cleaner plugs, a warning is displayed on the monitor screen inside the cab.

Pump Compartment. A service door on the right side of the upper structure allows ground-level access to the pump and pilot filter.

Radiator Compartment. The left rear service door allows easy access to the engine radiator, oil cooler and air-to-air-after-cooler. A reserve tank and drain cock are attached to the radiator for simplified maintenance.

Capsule Filter. The hydraulic return filter, a capsule filter, is situated outside the hydraulic tank. This filter prevents contaminants from entering the system when hydraulic oil is changed and keeps the operation clean.

Greasing Points. A concentrated remote greasing block on the boom delivers grease to hard-to-reach locations on the front.

Fan Guard. Engine radiator fan is completely enclosed by fine wire mesh, reducing the risk of an accident.

Anti-Skid Plate. Anti-skid plate covers top of storage box and upper structure to prevent slipping during maintenance.

Diagnostics and Monitoring. The 336D is equipped with S•O•SSM sampling ports and hydraulic test ports for the hydraulic system, engine oil, and for coolant. A test connection for the Cat Electronic Technician (Cat ET) service tool is located in the cab.

Extended Service Interval. 336D service and maintenance intervals have been extended to reduce machine service time and increase machine availability.



Complete Customer Support

Cat dealer services help you operate longer with lower costs.



Product Support. You will find nearly all parts at our dealer parts counter. Cat dealers utilize a worldwide computer network to find in-stock parts to minimize machine down time. Save money with remanufactured components.

Machine Selection. Make detailed comparisons of the machines you are considering before you buy. What are the job requirements, machine attachments and operating hours? What production is needed? Your Cat dealer can provide recommendations.

Purchase. Look past initial price. Consider the financing options available as well as day-to-day operating costs. This is also the time to look at dealer services that can be included in the cost of the machine to yield lower equipment owning and operating costs over the long run.

Customer Support Agreements. Cat dealers offer a variety of product support agreements, and work with customers to develop a plan the best meets specific needs. These plans can cover the entire machine, including attachments, to help protect the customer's investment.

Operation. Improving operating techniques can boost your profits. Your Cat dealer has videotapes, literature and other ideas to help you increase productivity, and Caterpillar offers certified operator training classes to help maximize the return on your investment.

Maintenance Services. Repair option programs guarantee the cost of repairs up front. Diagnostic programs such as Scheduled Oil Sampling, Coolant Sampling and Technical Analysis help you avoid unscheduled repairs.

Replacement. Repair, rebuild, or replace? Your Cat dealer can help you evaluate the cost involved so you can make the right choice.

SAFETY.CAT.COM™.

JC Machinery SUNIGHT
excavatorhunter.com

Engine

Engine Model	Cat C9 with ACERT Technology
Net Flywheel Power	200 kW
Net Power – ISO 9249	200 kW
Bore	112 mm
Stroke	149 mm
Displacement	8.8 L

- Net power advertised is the power available at the flywheel when the engine is equipped with fan, air cleaner, muffler and alternator.
- No engine derating needed up to 2300 m.

Weights

Operating Weight – Std. Undercarriage	33 750 kg
Operating Weight – Long Undercarriage	35 020 kg

- Reach boom, R3.2DB Stick, 1.4 m³ Bucket, 600 mm Shoes
- Reach boom, R3.2DB Stick, 1.5 m³ Bucket, 700 mm Shoe

Track

Standard w/Standard Undercarriage	700 mm
Standard w/Long Undercarriage	800 mm
Optional – Double Grouser	600 mm

Swing Mechanism

Swing Speed	10 rpm
Swing Torque	108.6 kN•m

Drive

Maximum Drawbar Pull	300 kN
Maximum Travel Speed	5 km/h

Hydraulic System

Main Implement System – Maximum Flow (2x)	280 L/min
Max. Pressure – Equipment	35 000 kPa
Max. Pressure – Travel	35 000 kPa
Max. Pressure – Swing	28 000 kPa
Pilot System – Maximum Flow	43 L/min
Pilot System – Maximum Pressure	3900 kPa
Boom Cylinder – Bore	150 mm
Boom Cylinder – Stroke	1440 mm
Stick Cylinder – Bore	170 mm
Stick Cylinder – Stroke	1738 mm
DB Family Bucket Cylinder – Bore	150 mm
DB Family Bucket Cylinder – Stroke	1151 mm
TB1 Family Bucket Cylinder – Bore	160 mm
TB1 Family Bucket Cylinder – Stroke	1356 mm

Service Refill Capacities

Fuel Tank Capacity	620 L
Cooling System	40 L
Engine Oil	40 L
Swing Drive	19 L
Final Drive (each)	8 L
Hydraulic System (including tank)	410 L
Hydraulic Tank	175 L

Sound Performance

Performance	ANSI/SAE J1166 OCT 98
-------------	-----------------------

- When properly installed and maintained, the cab offered by Caterpillar, when tested with doors and windows closed according to ANSI/SAE J1166 OCT 98, meets OSHA and MSHA requirements for operator sound exposure limits in effect at time of manufacture.
- Hearing protection may be needed when operating with an open operator station and cab (when not properly maintained or doors/windows open) for extended periods or in noisy environment.

Standards

Brakes	SAE J1026 APR90
Cab/FOGS	SAE J1356 FEB88 ISO 10262

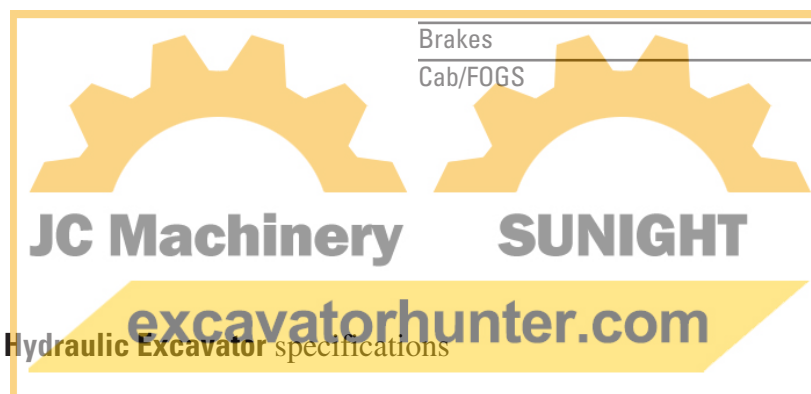

Dimensions

All dimensions are approximate.

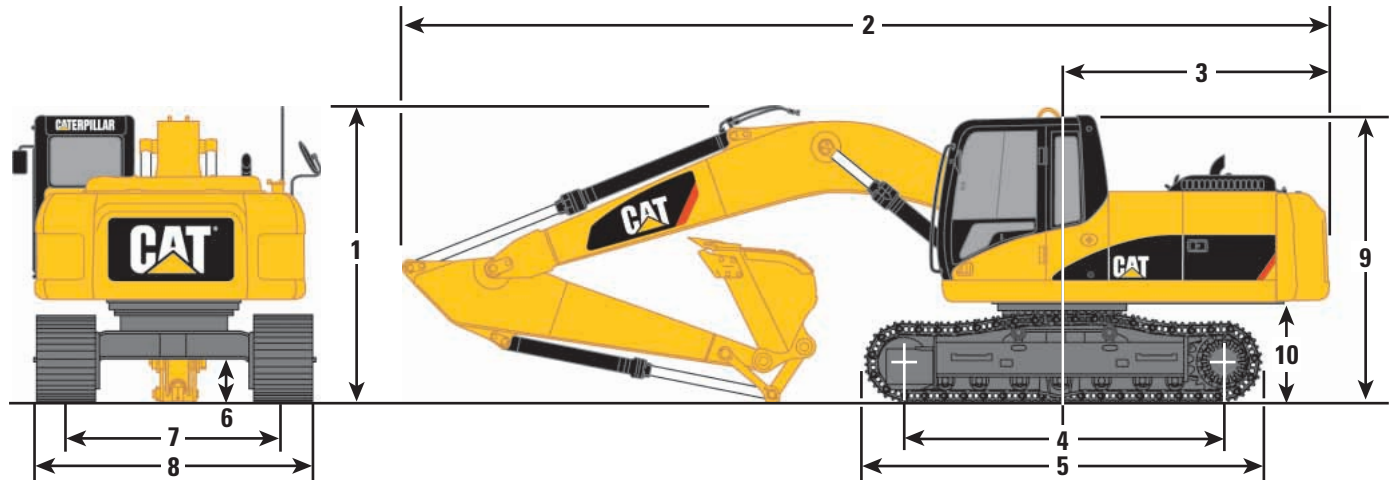

Boom Options	Reach Boom 6.5 m			Mass Boom 6.18 m		
Stick Options	R3.9DB	R3.2DB	R2.8DB	R2.15TB1	M2.55TB1	M2.15TB1
1 Shipping height**	3700 mm	3340 mm	3570 mm	3540 mm	3650 mm	3680 mm
2 Shipping length	11 200 mm	11 150 mm	11 210 mm	11 500 mm	10 910 mm	11 200 mm
3 Tail swing radius	3500 mm	3500 mm	3500 mm	3500 mm	3500 mm	3500 mm
Undercarriage	Fixed Gauge		Long Fixed Gauge			
4 Length to center of rollers	3610 mm		4040 mm			
5 Track length	4590 mm		5020 mm			
6 Ground clearance***	450 mm		450 mm			
7 Track gauge	2590 mm		2590 mm			
8 Track width*	3190 mm		3290 mm			
9 Cab height**	3140 mm		3140 mm			
10 Counterweight clearance***	1220 mm		1220 mm			

* Track width shown is for 600 mm track shoes for Fixed Gauge and 700 mm for Long Fixed Gauge.

** Includes 30 mm shoe lug height.

*** Without 30 mm shoe lug height.

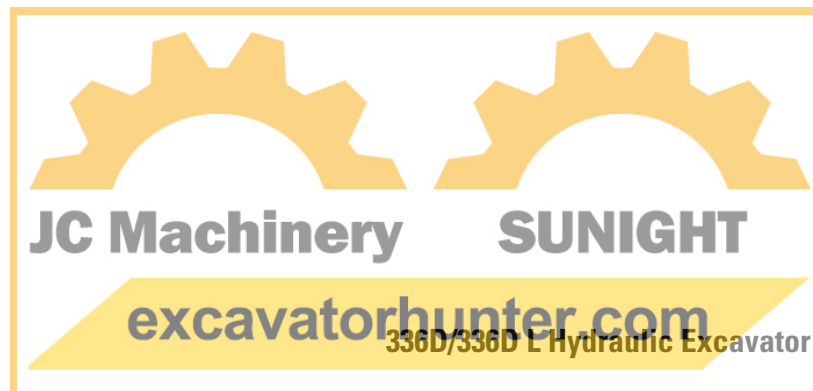

Reach Excavator Working Ranges

Reach (R) boom configuration

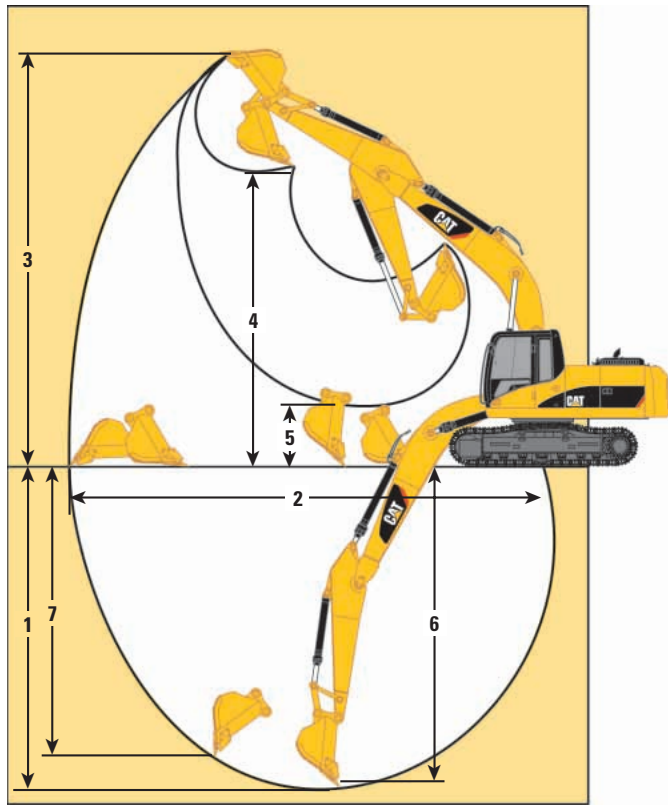

Mass Excavator Working Ranges

Mass (M) boom configuration

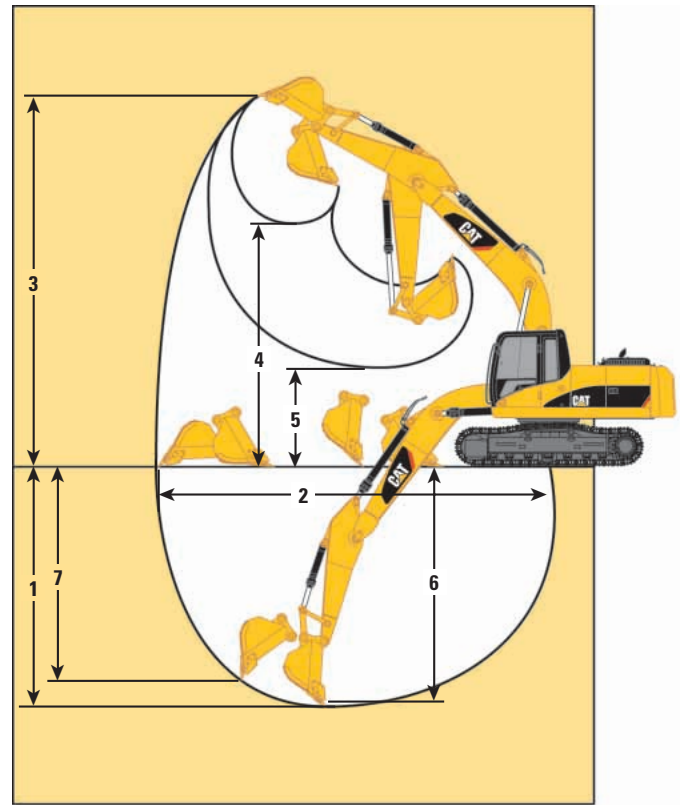

Boom Options

Reach Boom 6.5 m

Mass Boom 6.18 m

Stick Options

	R3.9DB	R3.2DB	R2.8DB	R2.15TB1	M2.55TB1	M2.15TB1
1 Maximum digging depth	8090 mm	7390 mm	6990 mm	6500 mm	6570 mm	6170 mm
2 Maximum reach at ground level	11 640 mm	10 920 mm	10 620 mm	10 070 mm	10 180 mm	9760 mm
3 Maximum cutting height	10 710 mm	10 240 mm	10 300 mm	9820 mm	10 070 mm	9740 mm
4 Maximum loading height	7640 mm	7200 mm	7200 mm	6530 mm	6690 mm	6410 mm
5 Minimum loading height	2010 mm	2710 mm	3110 mm	3590 mm	3000 mm	3400 mm
6 Maximum depth cut for 2240 mm level bottom	7960 mm	7230 mm	6820 mm	6280 mm	6400 mm	5970 mm
7 Maximum vertical wall digging depth	6700 mm	5830 mm	5770 mm	4800 mm	5340 mm	4710 mm
Bucket digging force (SAE)	198 kN	198 kN	198 kN	234 kN	234 kN	234 kN
(ISO)	222 kN	222 kN	222 kN	264 kN	264 kN	264 kN
Stick digging force (SAE)	143 kN	164 kN	183 kN	215 kN	185 kN	215 kN
(ISO)	146 kN	169 kN	188 kN	224 kN	192 kN	224 kN

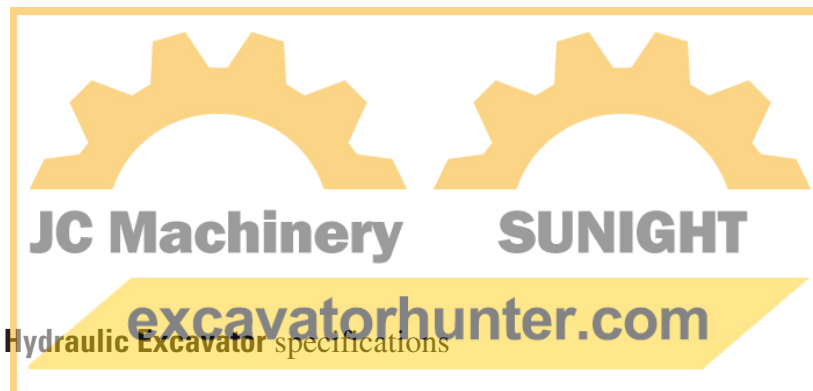

Major Component Weights

		kg
Base machine with counterweight and 800 mm shoes (without front linkage)	With 600 mm Shoe	26 160
	With 700 mm Shoe	27 390
Two boom cylinders (Each)		320
Counterweight		
Non-removal type		6020
Boom (includes lines, pins and stick cylinder)		
Reach boom		3227
Mass boom		3255
Stick (includes lines, pins, bucket cylinder and linkage)		
R3.9DB		2012
R3.2DB		1867
R2.8DB		1792
R2.15TB1		2011
M2.55TB1		2079
M2.15TB1		2011
Track roller frame [includes frame, rollers, idlers, steps, guards, final drive, 800 mm shoes] – each	With 600 mm Shoe	11 980
	With 700 mm Shoe	13 210

336D/336D L Work Tool Matching Guide

Boom Options	Reach Boom 6.5 m			Mass Boom 6.18 m		
	R3.9DB	R3.2DB	R2.80DB	R2.15TB1	M2.55TB1	M2.15TB1
Stick Options						
Hydraulic Hammer	H130s/ H140Ds/ H160Ds	H130s/ H140Ds/ H160Ds	H130s/ H140Ds/ H160Ds	H130s/ H140Ds/ H160Ds	H130s/ H140Ds/ H160Ds	H130s/ H140Ds/ H160Ds
Vibratory Plate Compactor	CVP110	CVP110	CVP110	CVP110	CVP110	CVP110
Multi-Processor	MP20	MP20	MP20	n/a	n/a	n/a
360 Scrap Shear	S320	S320	S320	n/a	n/a	n/a
Trash Grapple	4.4 m ³ 5.8 m ³	4.4 m ³ 5.8 m ³	4.4 m ³ 5.8 m ³	n/a	n/a	n/a
Dedicated Quick Coupler	yes	yes	yes	yes	yes	yes
Pin-Grabber Quick Coupler	yes	yes	yes	yes	yes	yes
Contractors' Grapple	yes	yes	yes	yes	n/a	n/a
Hydraulic Thumb	yes	yes	yes	yes	n/a	n/a

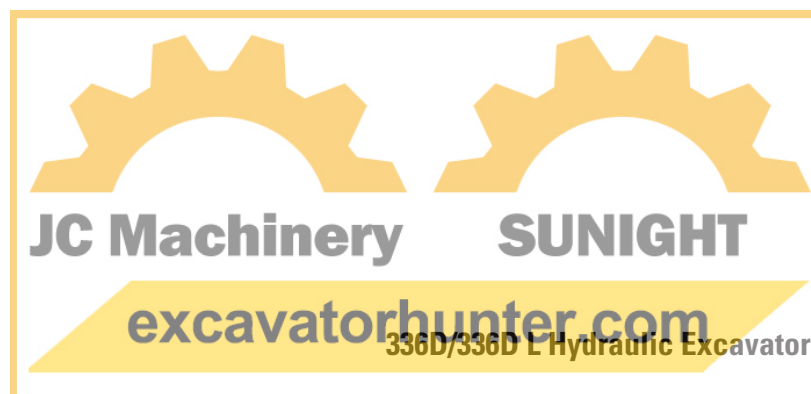

336D Bucket Specifications and Compatibility

	Capacity	Width	Tip Radius	Weight (w/o tips)	Teeth	Total Weight	Reach Stick			Mass Stick		
	m ³	mm	mm	kg	Qty	kg	R3.9DB	R3.2DB	R2.8DB	R2.15TB1	M2.55TB1	M2.15TB1
DB Buckets												
Excavation	1.4	1472	1660	1124	5	1124	●	●	●	—	—	—
	1.5	1559	1660	1167	5	1167	◐	●	●	—	—	—
Heavy Duty	1.4	1500	1691	1305	5	1305	◐	●	●	—	—	—
	1.5	1585	1691	1352	5	1352	◐	●	●	—	—	—
Mass Excavation	1.6	1538	1660	1214	6	1214	◐	●	●	—	—	—
	1.9	1780	1660	1336	6	1336	○	◐	◐	—	—	—
TB Buckets												
Excavation	1.6	1360	1821	1405	4	1405	—	—	—	●	●	●
	1.9	1560	1821	1546	5	1546	—	—	—	●	●	●
	2.0	1628	1821	1583	5	1583	—	—	—	◐	◐	●

336D L Bucket Specifications and Compatibility

	Capacity	Width	Tip Radius	Weight (w/o tips)	Teeth	Total Weight	Reach Stick			Mass Stick		
	m ³	mm	mm	kg	Qty	kg	R3.9DB	R3.2DB	R2.8DB	R2.15TB1	M2.55TB1	M2.15TB1
DB Buckets												
Excavation	1.4	1472	1660	1124	5	1124	●	●	●	—	—	—
	1.5	1559	1660	1167	5	1167	●	●	●	—	—	—
Heavy Duty	1.4	1500	1691	1305	5	1305	●	●	●	—	—	—
	1.5	1585	1691	1352	5	1352	●	●	●	—	—	—
Mass Excavation	1.6	1538	1660	1214	6	1214	◐	●	●	—	—	—
	1.9	1780	1660	1336	6	1336	○	◐	●	—	—	—
TB Buckets												
Excavation	1.6	1360	1821	1405	4	1405	—	—	—	●	●	●
	1.9	1560	1821	1546	5	1546	—	—	—	●	●	●
	2.0	1628	1821	1583	5	1583	—	—	—	◐	●	●

Assumptions for maximum material density rating:

1. Front linkage fully extended at ground line
2. Bucket curled
3. 100% bucket fill factor

* Based on SAE J296, some calculations of capacity specs fall on borderlines. Rounding may allow two buckets to have the same English rating, but different metric ratings.

- 2100 kg/m³ max material density
- ◐ 1800 kg/m³ max material density
- 1500 kg/m³ max material density
- ∴ 1200 kg/m³ max material density
- Not Available

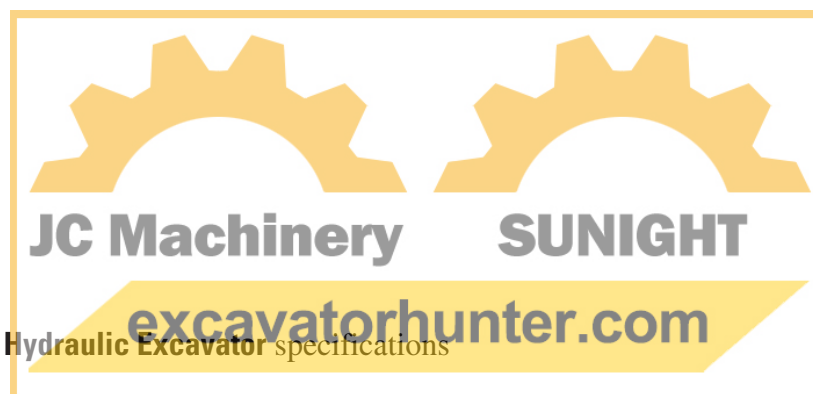

Reach Boom Lift Capacities



Load Point Height



Load Radius Over Front



Load Radius Over Side



















Load at Maximum Reach

R3.2DB STICK – 3200 mm
BUCKET – 1.5 m³

UNDERCARRIAGE – Long
SHOES – 600 mm triple grouser

BOOM – 6500 mm















	1.5 m		3.0 m		4.5 m		6.0 m		7.5 m		9.0 m				m	
																
9.0 m	kg													*3900	*3900	8.27
7.5 m	kg								*6450	6350				*3700	*3700	9.43
6.0 m	kg								*6700	6300				*3650	3500	10.16
4.5 m	kg							*8450	*8450	*7350	6050	*6750	4250	*3700	3100	10.59
3.0 m	kg					*13 750	13 050	*10 050	8300	*8200	5750	6950	4100	*3900	2950	10.76
1.5 m	kg					*16 350	11 900	*11 500	7700	*9050	5400	6800	3950	*4200	2900	10.67
Ground Line	kg			*6800	*6800	*17 500	11 300	*12 450	7300	8900	5200	6650	3850	*4700	3050	10.33
-1.5 m	kg	*8150	*8150	*12 000	*12 000	*17 500	11 150	12 550	7100	8750	5050	6600	3800	*5450	3400	9.71
-3.0 m	kg	*13 350	*13 350	*18 300	*18 300	*16 500	11 250	*12 250	7100	8800	5050			*6750	4100	8.74
-4.5 m	kg			*19 800	*19 800	*14 350	11 550	*10 700	7300					*5950	5750	7.28
-6.0 m	kg					*10 050	*10 050							*7750	*7750	5.47

* Limited by hydraulic capacity rather than tipping load. The above loads are in compliance with SAE hydraulic excavator lift capacity rating standard J1097. They do not exceed 87% of hydraulic lifting capacity or 75% of tipping capacity. Weight of all lifting accessories must be deducted from the above lifting capacities.

R2.8DB STICK – 2800 mm
BUCKET – 1.6 m³

UNDERCARRIAGE – Long
SHOES – 600 mm triple grouser

BOOM – 6500 mm

	3.0 m		4.5 m		6.0 m		7.5 m		9.0 m				m	
														
9.0 m	kg											*4900	*4900	7.85
7.5 m	kg							*6850	6250			*4600	4450	9.07
6.0 m	kg							*7100	6150			*4500	3700	9.84
4.5 m	kg			*11 400	*11 400	*8950	8800	*7700	5950	7000	4150	*4550	3250	10.29
3.0 m	kg			*14 600	12 750	*10 500	8150	*8500	5650	6900	4050	*4750	3050	10.46
1.5 m	kg			*16 900	11 700	*11 850	7650	9150	5400	6750	3900	*5100	3050	10.37
Ground Line	kg			*17 650	11 250	*12 650	7300	8900	5150	6650	3850	5600	3200	10.02
-1.5 m	kg	*11 400	*11 400	*17 300	11 200	12 600	7150	8800	5100			6250	3600	9.38
-3.0 m	kg	*19 250	*19 250	*16 000	11 350	*12 000	7200	8850	5150			*6750	4450	8.36
-4.5 m	kg	*18 150	*18 150	*13 500	11 750	*10 000	7450					*5900	*5900	6.82

* Limited by hydraulic capacity rather than tipping load. The above loads are in compliance with SAE hydraulic excavator lift capacity rating standard J1097. They do not exceed 87% of hydraulic lifting capacity or 75% of tipping capacity. Weight of all lifting accessories must be deducted from the above lifting capacities.

Always refer to the appropriate Operation and Maintenance Manual for specific product information.

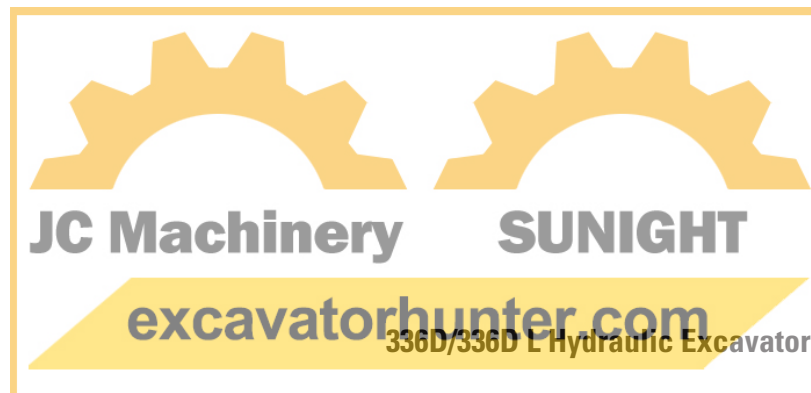

Reach Boom Lift Capacities



Load Point Height



Load Radius Over Front



Load Radius Over Side



Load at Maximum Reach

R3.2DB STICK – 3200 mm
BUCKET – 1.5 m³

UNDERCARRIAGE – Standard
SHOES – 600 mm triple grouser

BOOM – 6500 mm

Load Point Height	1.5 m		3.0 m		4.5 m		6.0 m		7.5 m		9.0 m		Load at Maximum Reach		m	
	Over Front	Over Side	Over Front	Over Side	Over Front	Over Side	Over Front	Over Side	Over Front	Over Side	Over Front	Over Side	Over Front	Over Side		
9.0 m	kg													*3900	*3900	8.27
7.5 m	kg								*6450	6200				*3700	*3700	9.43
6.0 m	kg								*6700	6150				*3650	3400	10.16
4.5 m	kg							*8450	*8450	*7350	5900	5950	4150	*3700	3000	10.59
3.0 m	kg					*13 750	12 750	*10 050	8100	7950	5600	5750	4000	*3900	2850	10.76
1.5 m	kg					*16 350	11 600	10 900	7500	7600	5250	5600	3850	4200	2800	10.67
Ground Line	kg			*6800	*6800	16 850	11 000	10 500	7100	7350	5000	5450	3700	4400	2900	10.33
-1.5 m	kg	*8150	*8150	*12 000	*12 000	16 650	10 850	10 250	6900	7200	4900	5400	3650	4850	3250	9.71
-3.0 m	kg	*13 350	*13 350	*18 300	*18 300	*16 500	10 950	10 250	6900	7250	4900			5850	4000	8.74
-4.5 m	kg			*19 800	*19 800	*14 350	11 250	10 500	7100					*5950	5550	7.28
-6.0 m	kg					*10 050	*10 050							*7750	*7750	5.47

* Limited by hydraulic capacity rather than tipping load. The above loads are in compliance with SAE hydraulic excavator lift capacity rating standard J1097. They do not exceed 87% of hydraulic lifting capacity or 75% of tipping capacity. Weight of all lifting accessories must be deducted from the above lifting capacities.

Mass Boom Lift Capacities



Load Point Height



Load Radius Over Front



Load Radius Over Side



Load at Maximum Reach

M2.55TB1 STICK – 2550 mm
BUCKET – 1.9 m³

UNDERCARRIAGE – Long
SHOES – 600 mm triple grouser

BOOM – 6180 mm

Load Point Height	3.0 m		4.5 m		6.0 m		7.5 m		Load at Maximum Reach		m	
	Over Front	Over Side	Over Front	Over Side	Over Front	Over Side	Over Front	Over Side	Over Front	Over Side		
7.5 m	kg								*3850	*3850	8.56	
6.0 m	kg					*7800	*7800	*7250	5800	*3750	3750	9.37
4.5 m	kg			*11 300	*11 300	*8950	8500	*7750	5600	*3800	3250	9.83
3.0 m	kg			*14 250	12 450	*10 350	7850	*8450	5350	*4000	3000	9.99
1.5 m	kg			*16 450	11 300	*11 600	7300	8800	5050	*4350	3000	9.87
Ground Line	kg			*17 150	10 800	*12 250	6900	8600	4850	*4900	3200	9.48
-1.5 m	kg	*15 350	*15 350	*16 650	10 750	*12 200	6800	8500	4750	*5800	3750	8.76
-3.0 m	kg	*20 700	*20 700	*15 050	10 950	*11 200	6900			*6400	4950	7.62
-4.5 m	kg	*15 900	*15 900	*11 850	11 500	*8200	7300			*8100	7250	6.04

* Limited by hydraulic capacity rather than tipping load. The above loads are in compliance with SAE hydraulic excavator lift capacity rating standard J1097. They do not exceed 87% of hydraulic lifting capacity or 75% of tipping capacity. Weight of all lifting accessories must be deducted from the above lifting capacities.

Always refer to the appropriate Operation and Maintenance Manual for specific product information.

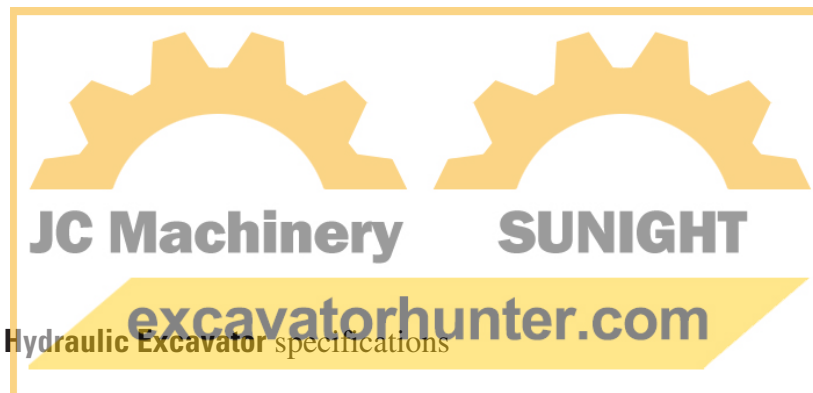

Standard Equipment

Standard equipment may vary. Consult your Caterpillar dealer for details.

Upper Structure

Electrical

- Alternator, 80A
- Light, storage box mounted (one)
- Signaling/Warning horn

Engine

- Cat C9 with ACERT Technology
- Cooling package, high ambient, 48° C with VSF for standard power
- 2300 m altitude capability with no deration
- Air intake heater
- Automatic engine speed control
- EU Stage II compliant
- Radial seal air filter
- Water separator in fuel line
- Waved fin radiator with space for cleaning
- 2 micron fuel filter
- Automatic swing parking brake
- Boom drift reducing valve
- Boom lowering device for back-up
- Caterpillar one key security system
- Counterweight
- Door locks and cap locks
- Mirrors, rearview (frame-right, cab-left)
- Regeneration circuit for boom and stick
- Reverse swing damping valve
- Stick drift reducing valve
- Two speed travel

Operator Station

Cab

- Adjustable armrest
- Ashtray with lighter
- Beverage holder
- Bi-Level air conditioner (automatic) with defroster
- Bolt-on FOGS capability
- Capability of installing two additional pedals
- Coat hook
- Front windshield glass split 70/30
- Interior lighting
- Literature holder
- Mounting for two stereo speakers (two locations)
- Neutral lever (lock out) for all controls
- Openable front windshield with assist device
- Openable skylight
- Pillar mounted upper windshield wiper and washer
- Pressurized cab (positive filtered ventilation)
- Radio mounting (DIN size)
- Rear window, emergency exit
- Removable lower windshield with in-cab storage bracket
- Seat with integrated, adjustable console
- Seat belt, retractable (50.8 mm width)
- Sliding upper door window
- Storage compartment suitable for lunch box
- Travel control pedals with removable hand levers
- Utility space for magazine
- Washable floor mat

Monitor

- Economy mode
- Full time clock
- Language display – Full color and graphical display
- Machine condition, error code and tool mode setting
- Start-up level check for hydraulic oil, engine oil and coolant
- Warning information, filter/fluid change information and working hour

Undercarriage

- Grease lubricated GLT2, resin seal
- Idler and center section track guiding
- 800 mm triple grouser track shoe (336D L)
- 700 mm triple grouser track shoes (336D)

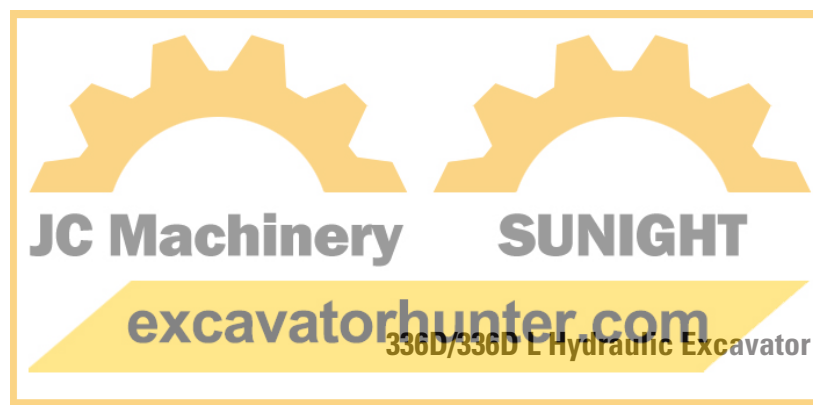

Optional Equipment

Optional equipment may vary. Consult your Caterpillar dealer for details.

Front Linkage

- Bucket linkage, DB-family with lifting eye
- Bucket linkage, TB1-family with lifting eye
- Heavy-duty 6.5 m reach boom (with left and right side light)
- Heavy-duty 3.2 m stick for heavy-duty reach boom
- Heavy-duty 2.8 m stick for heavy-duty reach boom
- Reach boom 6.5 m with left and right side light
 - R3.9DB 3900 mm stick
 - R3.2DB 3000 mm stick
 - R2.8DB 2800 mm stick
 - R2.15TB1 2150 mm stick
- Mass boom 6.18 m with left and right side light
 - M2.55TB1 2550 mm stick
 - M2.15TB1 2150 mm stick

Track

- Standard undercarriage
 - 700 mm triple grouser shoes
 - 800 mm triple grouser shoes
- Long undercarriage
 - 600 mm triple grouser shoes
 - 700 mm triple grouser shoes

Guards

- FOGS, bolt-on
- Guard, cab front
- Guard, cab top
- Guard, full length for long undercarriage (two piece)
- Guard, heavy-duty bottom, 4 mm, without swivel guard and travel motor protection
- Guard, track end guide for long undercarriage
- Guard, track end guide for standard undercarriage
- Guard, vandalism
- Heavy-duty swivel protection, 16 mm, swivel guard only
- Heavy-duty travel motor protection
- Net for front guard (full net, one piece)
- Net for front guard (half net, one piece)
- Swivel protection, 6 mm, swivel guard only

Auxiliary Hydraulics and Lines

- Additional circuit
 - Hammer return filter circuit
- Boom and stick lines
 - Cat quick coupler line (high and medium pressure capable)
 - Drain line
 - High pressure line
 - Medium pressure line
- Quick coupler
 - Quick coupler for high pressure
- Tool control system
 - Configuration 1 (hammer 1), foot pedal operated 1P, one-way circuit
 - Configuration 2 (common), foot pedals operated 1/2P, common circuit
 - Configuration 3 (hammer 2), foot pedal operated 2P, one-way circuit

Operator Station

- Tempered glass windows
 - Polycarbonate windows
 - Power supply, 12V-7A (1)
 - Power supply, 12V-7A (2)
 - Rear window emergency exit
 - Seat, high-back air suspension
 - Seat, high-back air suspension with heater
 - Seat, high-back mechanical suspension
 - Seat, low-back suspension without headrest
 - Headrest
 - Sunscreen
 - Windshield wiper, lower with washer
 - Working lights, cab mounted
 - Rain protector for front windshield
 - Sun visor
 - AM/FM radio
 - Control pattern quick-changer, two way
 - Control pattern quick-changer, four way
 - Cat MSS (anti-theft device)
 - Lunch box with cover
 - Water level indicator for water separator
- ### Other Optional Equipment
- Additional gear train for auxiliary pump
 - Air pre-filter
 - Electric refueling pump with auto shut off
 - Fine swing
 - Starting kit, cold weather, -32° C
 - Travel alarm

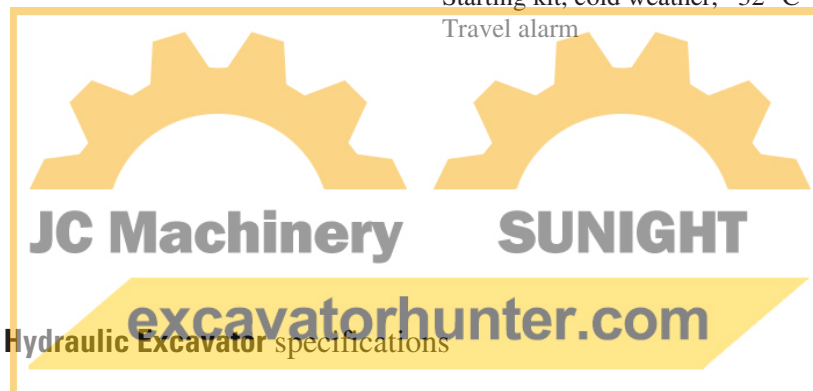

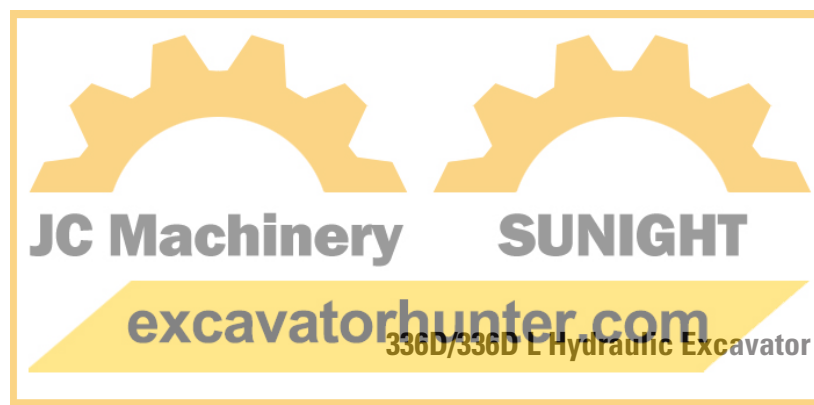

336D/336D L Hydraulic Excavator

AEHQ5991 (8-08)

Replaces AEHQ5668-03

APD

For more complete information on Cat products, dealer services,
and industry solutions, visit us on the web at www.cat.com

© 2008 Caterpillar
All Rights Reserved
Printed in U.S.A.

Materials and specifications are subject to change without notice.
Featured machines in photos may include additional equipment.
See your Caterpillar dealer for available options.

CAT, CATERPILLAR, ACERT, SAFETY.CAT.COM, their respective logos, "Caterpillar Yellow"
and the POWER EDGE trade dress, as well as corporate and product identity used
herein, are trademarks of Caterpillar and may not be used without permission.

